

# LMH6611/LMH6612

## Single Supply 345 MHz Rail-to-Rail Output Amplifiers

### General Description

The LMH6611 (single, with shutdown) and LMH6612 (dual) are 345 MHz rail-to-rail output amplifiers consuming just 3.2 mA of quiescent current per channel and designed to deliver high performance in power conscious single supply systems. The LMH6611 and LMH6612 have precision trimmed input offset voltages with low noise and low distortion performance as required for high accuracy video, test and measurement, and communication applications. The LMH6611 and LMH6612 are members of the PowerWise family and have an exceptional power-to-performance ratio.

With a trimmed input offset voltage of 0.022 mV and a high open loop gain of 103 dB the LMH6611 and LMH6612 meet the requirements of DC sensitive high speed applications such as low pass filtering in baseband I and Q radio channels. These specifications combined with a 0.01% settling time of 100 ns, a low noise of 10 nV/ $\sqrt{\text{Hz}}$  and better than 102 dBc SFDR at 100 kHz make these amplifiers particularly suited to driving 10, 12 and 14-bit high speed ADCs. The 45 MHz 0.1 dB bandwidth ( $A_V = 2$ ) driving 2  $V_{PP}$  into 150 $\Omega$  allows the amplifiers to be used as output drivers in 1080i and 720p HDTV applications.

The input common mode range extends from 200 mV below the negative supply rail up to 1.2V from the positive rail. On a single 5V supply with a ground terminated 150 $\Omega$  load the output swings to within 49 mV of the ground, while a mid-rail terminated 1 k $\Omega$  load will swing to 77 mV of either rail.

The amplifiers will operate on a 2.7V to 11V single supply or  $\pm 1.35\text{V}$  to  $\pm 5.5\text{V}$  split supply. The LMH6611 single is available in 6-Pin TSOT23 and has an independent active low disable pin which reduces the supply current to 120  $\mu\text{A}$ . The LMH6612 is available in 8-Pin SOIC. Both the LMH6611 and LMH6612 are available in  $-40^\circ\text{C}$  to  $+125^\circ\text{C}$  extended industrial temperature grade.

### Features

$V_S = 5\text{V}$ ,  $R_L = 1\text{ k}\Omega$ ,  $T_A = 25^\circ\text{C}$  and  $A_V = +1$ , unless otherwise specified.

|  |                                 |
|--|---------------------------------|
| ■ Operating voltage range  | 2.7V to 11V                     |
| ■ Supply current per channel                                       | 3.2 mA                          |
| ■ Small signal bandwidth   | 345 MHz                         |
| ■ Open loop gain   | 103 dB                          |
| ■ Input offset voltage (limit at 25°C)                             | $\pm 0.750\text{ mV}$           |
| ■ Slew rate  | 460 V/ $\mu\text{s}$            |
| ■ 0.1 dB bandwidth   | 45 MHz                          |
| ■ Settling time to 0.1%  | 67 ns                           |
| ■ Settling time to 0.01%   | 100 ns                          |
| ■ SFDR ( $f = 100\text{ kHz}$ , $A_V = 2$ , $V_{OUT} = 2 V_{PP}$ ) | 102 dBc                         |
| ■ Low voltage noise  | 10 nV/ $\sqrt{\text{Hz}}$       |
| ■ Output current   | $\pm 100\text{ mA}$             |
| ■ CMVR   | $-0.2\text{V}$ to $3.8\text{V}$ |
| ■ Rail-to-Rail output  |                                 |
| ■ $-40^\circ\text{C}$ to $+125^\circ\text{C}$ temperature range    |                                 |

### Applications

- ADC driver
- DAC buffer
- Active filters
- High speed sensor amplifier
- Current sense amplifier
- 1080i and 720p analog video amplifier
- STB, TV video amplifier
- Video switching and muxing

### Typical Application

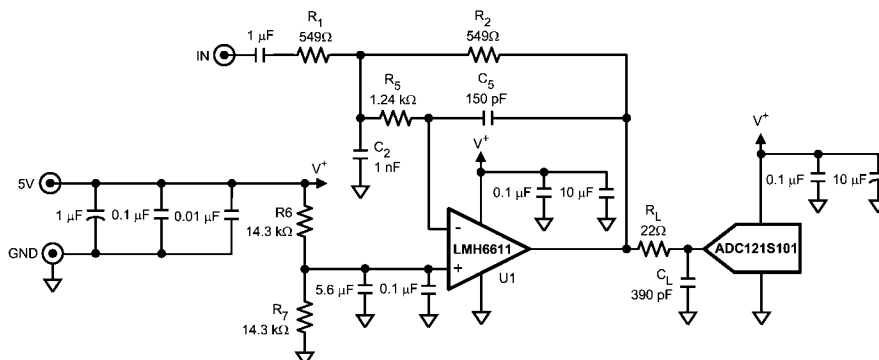

30033629

**Absolute Maximum Ratings** (Note 1)

If Military/Aerospace specified devices are required, please contact the National Semiconductor Sales Office/ Distributors for availability and specifications.

ESD Tolerance (Note 2)

Human Body Model

For input pins only

2000V

For all other pins

2000V

Machine Model

200V

Charge Device Model

1000V

Supply Voltage ( $V_S = V^+ - V^-$ )

12V

Junction Temperature (Note 3)

150°C max

**Operating Ratings** (Note 1)Supply Voltage ( $V_S = V^+ - V^-$ )

2.7V to 11V

Ambient Temperature Range (Note 3)

-40°C to +125°C

Package Thermal Resistance ( $\theta_{JA}$ )

6-Pin TSOT23

231°C/W

8-Pin SOIC

160°C/W

**+3V Electrical Characteristics**

Unless otherwise specified, all limits are guaranteed for  $T_J = +25^\circ\text{C}$ ,  $V^+ = 3\text{V}$ ,  $V^- = 0\text{V}$ ,  $V_S = V^+ - V^-$ ,  $\overline{\text{DISABLE}} = 3\text{V}$ ,  $V_{CM} = V_O = V^+/2$ ,  $A_V = +1$ ,  $R_F = 0\Omega$ , when  $A_V \neq +1$  then  $R_F = 560\Omega$ ,  $R_L = 1\text{ k}\Omega$ . **Boldface** limits apply at temperature extremes. (Note 4)

| Symbol                                  | Parameter                    | Condition   | Min<br>(Note 8) | Typ<br>(Note 7) | Max<br>(Note 8) | Units                        |
|---|------------------------------|---|-----------------|-----------------|-----------------|------------------------------|
| <b>Frequency Domain Response</b>        |                              |   |                 |                 |                 |                              |
| SSBW                                    | -3 dB Bandwidth Small Signal | $A_V = 1$ , $R_L = 1\text{ k}\Omega$ , $V_{OUT} = 0.2 V_{PP}$   |                 | 305             |                 | MHz                          |
|   |                              | $A_V = 2, -1$ , $R_L = 1\text{ k}\Omega$ , $V_{OUT} = 0.2 V_{PP}$   |                 | 115             |                 |                              |
| GBW                                     | Gain Bandwidth (LMH6611)     | $A_V = 10$ , $R_F = 2\text{ k}\Omega$ , $R_G = 221\Omega$ , $R_L = 1\text{ k}\Omega$ , $V_{OUT} = 0.2 V_{PP}$ | 115             | 135             |                 | MHz                          |
|   | Gain Bandwidth (LMH6612)     | $A_V = 10$ , $R_F = 2\text{ k}\Omega$ , $R_G = 221\Omega$ , $R_L = 1\text{ k}\Omega$ , $V_{OUT} = 0.2 V_{PP}$ |                 | 130             |                 |                              |
| LSBW                                    | -3 dB Bandwidth Large Signal | $A_V = 1$ , $R_L = 1\text{ k}\Omega$ , $V_{OUT} = 1.5 V_{PP}$   |                 | 90              |                 | MHz                          |
|   |                              | $A_V = -1$ , $R_L = 150\Omega$ , $V_{OUT} = 2 V_{PP}$   |                 | 85              |                 |                              |
| Peak                                    | Peaking                      | $A_V = 1$   |                 | 1.0             |                 | dB                           |
| 0.1<br>dBBW                             | 0.1 dB Bandwidth             | $A_V = 1$ , $V_{OUT} = 0.5 V_{PP}$ , $R_L = 1\text{ k}\Omega$   |                 | 33              |                 | MHz                          |
|   |                              | $A_V = 2$ , $V_{OUT} = 0.5 V_{PP}$ , $R_L = 1\text{ k}\Omega$<br>$R_F = R_G = 560\Omega$                      |                 | 65              |                 |                              |
|   |                              | $A_V = 2$ , $V_{OUT} = 1.5 V_{PP}$ , $R_L = 150\Omega$ ,<br>$R_F = R_G = 510\Omega$                           |                 | 47              |                 |                              |
| DG                                      | Differential Gain            | $A_V = 2$ , 4.43 MHz, $0.6\text{V} < V_{OUT} < 2\text{V}$ ,<br>$R_L = 150\Omega$ to $V^+/2$                   |                 | 0.03            |                 | %                            |
| DP                                      | Differential Phase           | $A_V = 2$ , 4.43 MHz, $0.6\text{V} < V_{OUT} < 2\text{V}$ ,<br>$R_L = 150\Omega$ to $V^+/2$                   |                 | 0.06            |                 | deg                          |
| <b>Time Domain Response</b>             |                              |   |                 |                 |                 |                              |
| $t_r/t_f$                               | Rise & Fall Time             | 1.5V Step, $A_V = 1$  |                 | 2.8             |                 | ns                           |
| SR                                      | Slew Rate                    | 2V Step, $A_V = 1$  |                 | 330             |                 | V/ $\mu\text{s}$             |
| $t_{s,0.1}$                             | 0.1% Settling Time           | 2V Step, $A_V = -1$   |                 | 74              |                 | ns                           |
| $t_{s,0.01}$                            | 0.01% Settling Time          | 2V Step, $A_V = -1$   |                 | 116             |                 |                              |
| <b>Noise and Distortion Performance</b> |                              |   |                 |                 |                 |                              |
| SFDR                                    | Spurious Free Dynamic Range  | $f_C = 100\text{ kHz}$ , $A_V = -1$ , $V_{OUT} = 2 V_{PP}$  |                 | 109             |                 | dBc                          |
|   |                              | $f_C = 1\text{ MHz}$ , $A_V = -1$ , $V_{OUT} = 2 V_{PP}$  |                 | 97              |                 |                              |
|   |                              | $f_C = 5\text{ MHz}$ , $A_V = -1$ , $V_{OUT} = 2 V_{PP}$  |                 | 80              |                 |                              |
| $e_n$                                   | Input Voltage Noise          | $f = 100\text{ kHz}$  |                 | 10              |                 | $\text{nV}/\sqrt{\text{Hz}}$ |
| $i_n$                                   | Input Current Noise          | $f = 100\text{ kHz}$  |                 | 2               |                 | $\text{pA}/\sqrt{\text{Hz}}$ |
| CT                                      | Crosstalk (LMH6612)          | $f = 5\text{ MHz}$ , $V_{IN} = 2 V_{PP}$  |                 | 71              |                 | dB                           |

| Symbol                           | Parameter  | Condition   | Min<br>(Note 8)           | Typ<br>(Note 7) | Max<br>(Note 8)                            | Units             |  |          |
|----------------------------------|--|---|---------------------------|-----------------|--|-------------------|--|----------|
| <b>Input, DC Performance</b>     |  |   |                           |                 |  |                   |  |          |
| $V_{OS}$                         | Input Offset Voltage (LMH6611)                               | $V_{CM} = 0.5V$                                       |                           | 0.022           | $\pm 0.600$<br><b><math>\pm 1.0</math></b> | mV                |  |          |
|                                  | Input Offset Voltage (LMH6612)                               | $V_{CM} = 0.5V$                                       |                           | -0.015          | $\pm 0.750$<br><b><math>\pm 1.3</math></b> |                   |  |          |
| $TCV_{OS}$                       | Input Offset Voltage Average Drift                           | (Note 5)  |                           | 0.1             |  | $\mu V/^{\circ}C$ |  |          |
| $I_B$                            | Input Bias Current   | $V_{CM} = 0.5V$                                       |                           | -5.9            | -10.1<br><b>-11.1</b>                      | $\mu A$           |  |          |
| $I_O$                            | Input Offset Current   |   |                           | 0.01            | $\pm 0.5$<br><b><math>\pm 0.7</math></b>   | $\mu A$           |  |          |
| $C_{IN}$                         | Input Capacitance  |   |                           | 2.5             |  | pF                |  |          |
| $R_{IN}$                         | Input Resistance   |   |                           | 6               |  | $M\Omega$         |  |          |
| CMVR                             | Input Voltage Range  | DC, CMRR $\geq 76$ dB                                 | -0.2                      |                 | 1.8  | V                 |  |          |
| CMRR                             | Common Mode Rejection Ratio                                  | $V_{CM}$ Stepped from -0.1V to 1.7V                   | 79                        | 98              |  | dB                |  |          |
| $A_{OL}$                         | Open Loop Gain   | $R_L = 1\text{ k}\Omega$ , $V_{OUT} = 2.7V$ to $0.3V$ | 89                        | 101             |  | dB                |  |          |
|                                  |  | $R_L = 150\Omega$ , $V_{OUT} = 2.5V$ to $0.5V$        | 78                        | 85              |  |                   |  |          |
| <b>Output DC Characteristics</b> |  |   |                           |                 |  |                   |  |          |
| $V_O$                            | Output Swing High (LMH6611)<br>(Voltage from V+ Supply Rail) | $R_L = 1\text{ k}\Omega$ to $V+/2$                    |                           | 59              | 72<br><b>76</b>                            | mV                |  |          |
|                                  |  | $R_L = 150\Omega$ to $V+/2$                           |                           | 133             | 169<br><b>182</b>                          |                   |  |          |
|                                  | Output Swing Low (LMH6611)<br>(Voltage from V- Supply Rail)  | $R_L = 1\text{ k}\Omega$ to $V+/2$                    |                           | 59              | 74<br><b>80</b>                            |                   |  |          |
|                                  |  | $R_L = 150\Omega$ to $V+/2$                           |                           | 133             | 171<br><b>188</b>                          |                   |  |          |
|                                  |  | $R_L = 150\Omega$ to $V^-$                            |                           | 42              | 52<br><b>56</b>                            |                   |  |          |
|                                  | Output Swing High (LMH6612)<br>(Voltage from V+ Supply Rail) | $R_L = 1\text{ k}\Omega$ to $V+/2$                    |                           | 58              | 68<br><b>73</b>                            |                   |  |          |
|                                  |  | $R_L = 150\Omega$ to $V+/2$                           |                           | 131             | 157<br><b>172</b>                          |                   |  |          |
|                                  | Output Swing Low (LMH6612)<br>(Voltage from V- Supply Rail)  | $R_L = 1\text{ k}\Omega$ to $V+/2$                    |                           | 61              | 71<br><b>79</b>                            |                   |  |          |
|                                  |  | $R_L = 150\Omega$ to $V+/2$                           |                           | 139             | 168<br><b>187</b>                          |                   |  |          |
|                                  |  | $R_L = 150\Omega$ to $V^-$                            |                           | 43              | 51<br><b>56</b>                            |                   |  |          |
|                                  | $I_{OUT}$  | Linear Output Current                                 | $V_{OUT} = V+/2$ (Note 6) |                 | $\pm 70$                                   |                   |  | mA       |
|                                  | $R_O$  | Output Resistance                                     | $f = 1\text{ MHz}$        |                 | 0.07                                       |                   |  | $\Omega$ |
| <b>Enable Pin Operation</b>      |  |   |                           |                 |  |                   |  |          |
|                                  | Enable High Voltage Threshold                                | Enabled (Note 9)                                      | 2.0                       |                 |  | V                 |  |          |
|                                  | Enable Pin High Current                                      | $V_{DISABLE} = 3V$                                    |                           | 0.001           |  | $\mu A$           |  |          |
|                                  | Enable Low Voltage Threshold                                 | Disabled (Note 9)                                     |                           |                 | 1.0  | V                 |  |          |
|                                  | Enable Pin Low Current                                       | $V_{DISABLE} = 0V$                                    |                           | 0.8             |  | $\mu A$           |  |          |
| $t_{on}$                         | Turn-On Time   |   |                           | 18              |  | ns                |  |          |
| $t_{off}$                        | Turn-Off Time  |   |                           | 50              |  | ns                |  |          |

| Symbol   | Parameter                                 | Condition  | Min<br>(Note 8) | Typ<br>(Note 7) | Max<br>(Note 8)    | Units          |
|--|---|--|-----------------|-----------------|--------------------|----------------|
| <b>Power Supply Performance</b>  |   |  |                 |                 |                    |                |
| PSRR   | Power Supply Rejection Ratio              | DC, $V_{CM} = 0.5V$ , $V_S = 2.7V$ to $11V$  | 81              | 96              |                    | dB             |
| $I_S$  | Supply Current (LMH6611)                  | $R_L = \infty$   |                 | 3.0             | 3.4<br><b>3.8</b>  | mA             |
|  | Supply Current (LMH6612)<br>(per channel) | $R_L = \infty$   |                 | 2.95            | 3.45<br><b>3.9</b> |                |
| $I_{SD}$   | Disable Shutdown Current<br>(LMH6611)     | $\overline{DISABLE} = 0V$  |                 | 101             | 132                | $\mu A$        |
| <b>+5V Electrical Characteristics</b>  |   |  |                 |                 |                    |                |
| Unless otherwise specified, all limits are guaranteed for $T_J = +25^\circ C$ , $V^+ = 5V$ , $V^- = 0V$ , $V_S = V^+ - V^-$ , $\overline{DISABLE} = 5V$ , $V_{CM} = V_O = V^+/2$ , $A_V = +1$ , $R_F = 0\Omega$ , when $A_V \neq +1$ then $R_F = 560\Omega$ , $R_L = 1\text{ k}\Omega$ . <b>Boldface</b> limits apply at temperature extremes. |   |  |                 |                 |                    |                |
| Symbol   | Parameter                                 | Condition  | Min<br>(Note 8) | Typ<br>(Note 7) | Max<br>(Note 8)    | Units          |
| <b>Frequency Domain Response</b>   |   |  |                 |                 |                    |                |
| SSBW   | -3 dB Bandwidth Small Signal              | $A_V = 1$ , $R_L = 1\text{ k}\Omega$ , $V_{OUT} = 0.2 V_{PP}$  |                 | 345             |                    | MHz            |
|  |   | $A_V = 2, -1$ , $R_L = 1\text{ k}\Omega$ , $V_{OUT} = 0.2 V_{PP}$  |                 | 112             |                    |                |
| GBW  | Gain Bandwidth<br>(LMH6611)               | $A_V = 10$ , $R_F = 2\text{ k}\Omega$ , $R_G = 221\Omega$ , $R_L = 1\text{ k}\Omega$ ,<br>$V_{OUT} = 0.2 V_{PP}$ | 115             | 135             |                    | MHz            |
|  | Gain Bandwidth<br>(LMH6612)               | $A_V = 10$ , $R_F = 2\text{ k}\Omega$ , $R_G = 221\Omega$ , $R_L = 1\text{ k}\Omega$ ,<br>$V_{OUT} = 0.2 V_{PP}$ |                 | 130             |                    |                |
| LSBW   | -3 dB Bandwidth Large Signal              | $A_V = 1$ , $R_L = 1\text{ k}\Omega$ , $V_{OUT} = 2 V_{PP}$  |                 | 77              |                    | MHz            |
|  |   | $A_V = 2$ , $R_L = 150\Omega$ , $V_{OUT} = 2 V_{PP}$   |                 | 85              |                    |                |
| Peak   | Peaking                                   | $A_V = 1$  |                 | 0.3             |                    | dB             |
| 0.1<br>dBBW  | 0.1 dB Bandwidth                          | $A_V = 1$ , $V_{OUT} = 0.5 V_{PP}$ , $R_L = 1\text{ k}\Omega$  |                 | 45              |                    | MHz            |
|  |   | $A_V = 2$ , $V_{OUT} = 0.5 V_{PP}$ , $R_L = 1\text{ k}\Omega$<br>$R_F = R_G = 680\Omega$                         |                 | 68              |                    |                |
|  |   | $A_V = 2$ , $V_{OUT} = 2 V_{PP}$ , $R_L = 150\Omega$ ,<br>$R_F = R_G = 665\Omega$                                |                 | 45              |                    |                |
| DG   | Differential Gain                         | $A_V = 2$ , 4.43 MHz, $0.6V < V_{OUT} < 2V$ ,<br>$R_L = 150\Omega$ to $V^+/2$                                    |                 | 0.05            |                    | %              |
| DP   | Differential Phase                        | $A_V = 2$ , 4.43 MHz, $0.6V < V_{OUT} < 2V$ ,<br>$R_L = 150\Omega$ to $V^+/2$                                    |                 | 0.06            |                    | deg            |
| <b>Time Domain Response</b>  |   |  |                 |                 |                    |                |
| $t_r/t_f$  | Rise & Fall Time                          | 2V Step, $A_V = 1$   |                 | 3.6             |                    | ns             |
| SR   | Slew Rate                                 | 2V Step, $A_V = 1$   |                 | 460             |                    | V/ $\mu s$     |
| $t_{s,0.1}$  | 0.1% Settling Time                        | 2V Step, $A_V = -1$  |                 | 67              |                    | ns             |
| $t_{s,0.01}$   | 0.01% Settling Time                       | 2V Step, $A_V = -1$  |                 | 100             |                    |                |
| <b>Distortion and Noise Performance</b>  |   |  |                 |                 |                    |                |
| SFDR   | Spurious Free Dynamic Range               | $f_C = 100\text{ kHz}$ , $A_V = 2$ , $V_{OUT} = 2 V_{PP}$  |                 | 102             |                    | dBc            |
|  |   | $f_C = 1\text{ MHz}$ , $A_V = 2$ , $V_{OUT} = 2 V_{PP}$  |                 | 96              |                    |                |
|  |   | $f_C = 5\text{ MHz}$ , $A_V = 2$ , $V_O = 2 V_{PP}$  |                 | 82              |                    |                |
| $e_n$  | Input Voltage Noise                       | $f = 100\text{ kHz}$   |                 | 10              |                    | $nV/\sqrt{Hz}$ |
| $i_n$  | Input Current Noise                       | $f = 100\text{ kHz}$   |                 | 2               |                    | $pA/\sqrt{Hz}$ |
| CT   | Crosstalk<br>(LMH6612)                    | $f = 5\text{ MHz}$ , $V_{IN} = 2 V_{PP}$   |                 | 71              |                    | dB             |

| Symbol                           | Parameter   | Condition   | Min<br>(Note 8) | Typ<br>(Note 7) | Max<br>(Note 8)                            | Units             |
|----------------------------------|---|---|-----------------|-----------------|--|-------------------|
| <b>Input, DC Performance</b>     |   |   |                 |                 |  |                   |
| $V_{OS}$                         | Input Offset Voltage (LMH6611)                                  | $V_{CM} = 0.5V$                                       |                 | 0.013           | $\pm 0.600$<br><b><math>\pm 1.0</math></b> | mV                |
|                                  | Input Offset Voltage (LMH6612)                                  | $V_{CM} = 0.5V$                                       |                 | 0.022           | $\pm 0.750$<br><b><math>\pm 1.3</math></b> |                   |
| $TCV_{OS}$                       | Input Offset Voltage Average Drift                              | (Note 5)  |                 | 0.1             |  | $\mu V/^{\circ}C$ |
| $I_B$                            | Input Bias Current  | $V_{CM} = 0.5V$                                       |                 | -6.3            | -10.1<br><b>-11.1</b>                      | $\mu A$           |
| $I_O$                            | Input Offset Current  |   |                 | 0.01            | $\pm 0.5$<br><b><math>\pm 0.7</math></b>   | $\mu A$           |
| $C_{IN}$                         | Input Capacitance   |   |                 | 2.5             |  | pF                |
| $R_{IN}$                         | Input Resistance  |   |                 | 6               |  | $M\Omega$         |
| CMVR                             | Input Voltage Range   | DC, CMRR $\geq 78$ dB                                 | -0.2            |                 | 3.8  | V                 |
| CMRR                             | Common Mode Rejection Ratio                                     | $V_{CM}$ Stepped from -0.1V to 3.7V                   | 81              | 98              |  | dB                |
| $A_{OL}$                         | Open Loop Gain  | $R_L = 1\text{ k}\Omega$ , $V_{OUT} = 4.6V$ to $0.4V$ | 92              | 103             |  | dB                |
|                                  |   | $R_L = 150\Omega$ , $V_{OUT} = 4.4V$ to $0.6V$        | 80              | 86              |  |                   |
| <b>Output DC Characteristics</b> |   |   |                 |                 |  |                   |
| $V_O$                            | Output Swing High (LMH6611)<br>(Voltage from $V^+$ Supply Rail) | $R_L = 1\text{ k}\Omega$ to $V+/2$                    |                 | 76              | 90<br><b>93</b>                            | mV                |
|                                  |   | $R_L = 150\Omega$ to $V+/2$                           |                 | 195             | 239<br><b>256</b>                          |                   |
|                                  | Output Swing Low (LMH6611)<br>(Voltage from $V^-$ Supply Rail)  | $R_L = 1\text{ k}\Omega$ to $V+/2$                    |                 | 74              | 92<br><b>98</b>                            |                   |
|                                  |   | $R_L = 150\Omega$ to $V+/2$                           |                 | 193             | 243<br><b>265</b>                          |                   |
|                                  |   | $R_L = 150\Omega$ to $V^-$                            |                 | 48              | 60<br><b>64</b>                            |                   |
|                                  | Output Swing High (LMH6612)<br>(Voltage from $V^+$ Supply Rail) | $R_L = 1\text{ k}\Omega$ to $V+/2$                    |                 | 75              | 86<br><b>91</b>                            |                   |
|                                  |   | $R_L = 150\Omega$ to $V+/2$                           |                 | 195             | 223<br><b>241</b>                          |                   |
|                                  | Output Swing Low (LMH6612)<br>(Voltage from $V^-$ Supply Rail)  | $R_L = 1\text{ k}\Omega$ to $V+/2$                    |                 | 77              | 88<br><b>98</b>                            |                   |
|                                  |   | $R_L = 150\Omega$ to $V+/2$                           |                 | 202             | 234<br><b>261</b>                          |                   |
| $R_L = 150\Omega$ to $V^-$       |   |   | 49              | 58<br><b>64</b> |  |                   |
| $I_{OUT}$                        | Linear Output Current   | $V_{OUT} = V+/2$ (Note 6)                             |                 | $\pm 100$       |  | mA                |
| $R_O$                            | Output Resistance   | $f = 1\text{ MHz}$                                    |                 | 0.07            |  | $\Omega$          |
| <b>Enable Pin Operation</b>      |   |   |                 |                 |  |                   |
|                                  | Enable High Voltage Threshold                                   | Enabled (Note 9)                                      | 3.0             |                 |  | V                 |
|                                  | Enable Pin High Current   | $V_{DISABLE} = 5V$                                    |                 | 1.2             |  | $\mu A$           |
|                                  | Enable Low Voltage Threshold                                    | Disabled (Note 9)                                     |                 |                 | 2.0  | V                 |
|                                  | Enable Pin Low Current  | $V_{DISABLE} = 0V$                                    |                 | 2.8             |  | $\mu A$           |
| $t_{on}$                         | Turn-On Time  |   |                 | 20              |  | ns                |
| $t_{off}$                        | Turn-Off Time   |   |                 | 60              |  | ns                |

| Symbol   | Parameter                                 | Condition  | Min<br>(Note 8) | Typ<br>(Note 7) | Max<br>(Note 8)    | Units          |
|--|---|--|-----------------|-----------------|--------------------|----------------|
| <b>Power Supply Performance</b>  |   |  |                 |                 |                    |                |
| PSRR   | Power Supply Rejection Ratio              | DC, $V_{CM} = 0.5V$ , $V_S = 2.7V$ to $11V$  | 81              | 96              |                    | dB             |
| $I_S$  | Supply Current (LMH6611)                  | $R_L = \infty$   |                 | 3.2             | 3.6<br><b>4.0</b>  | mA             |
|  | Supply Current (LMH6612)<br>(per channel) | $R_L = \infty$   |                 | 3.2             | 3.7<br><b>4.25</b> |                |
| $I_{SD}$   | Disable Shutdown Current<br>(LMH6611)     | $\overline{DISABLE} = 0V$  |                 | 120             | 162                | $\mu A$        |
| <b><math>\pm 5V</math> Electrical Characteristics</b>  |   |  |                 |                 |                    |                |
| Unless otherwise specified, all limits are guaranteed for $T_J = +25^\circ C$ , $V^+ = 5V$ , $V^- = -5V$ , $V_S = V^+ - V^-$ , $\overline{DISABLE} = 5V$ , $V_{CM} = V_O = 0V$ , $A_V = +1$ , $R_F = 0\Omega$ , when $A_V \neq +1$ then $R_F = 560\Omega$ , $R_L = 1\text{ k}\Omega$ . <b>Boldface</b> limits apply at temperature extremes. |   |  |                 |                 |                    |                |
| Symbol   | Parameter                                 | Condition  | Min<br>(Note 8) | Typ<br>(Note 7) | Max<br>(Note 8)    | Units          |
| <b>Frequency Domain Response</b>   |   |  |                 |                 |                    |                |
| SSBW   | -3 dB Bandwidth Small Signal              | $A_V = 1$ , $R_L = 1\text{ k}\Omega$ , $V_{OUT} = 0.2 V_{PP}$  |                 | 365             |                    | MHz            |
|  |   | $A_V = 2, -1$ , $R_L = 1\text{ k}\Omega$ , $V_{OUT} = 0.2 V_{PP}$  |                 | 110             |                    |                |
| GBW  | Gain Bandwidth<br>(LMH6611)               | $A_V = 10$ , $R_F = 2\text{ k}\Omega$ , $R_G = 221\Omega$ , $R_L = 1\text{ k}\Omega$ ,<br>$V_{OUT} = 0.2 V_{PP}$ | 115             | 135             |                    | MHz            |
|  | Gain Bandwidth<br>(LMH6612)               | $A_V = 10$ , $R_F = 2\text{ k}\Omega$ , $R_G = 221\Omega$ , $R_L = 1\text{ k}\Omega$ ,<br>$V_{OUT} = 0.2 V_{PP}$ |                 | 130             |                    |                |
| LSBW   | -3 dB Bandwidth Large Signal              | $A_V = 1$ , $R_L = 1\text{ k}\Omega$ , $V_{OUT} = 2 V_{PP}$  |                 | 85              |                    | MHz            |
|  |   | $A_V = 2$ , $R_L = 150\Omega$ , $V_{OUT} = 2 V_{PP}$   |                 | 87              |                    |                |
| Peak   | Peaking                                   | $A_V = 1$  |                 | 0.01            |                    | dB             |
| 0.1<br>dBBW  | 0.1 dB Bandwidth                          | $A_V = 1$ , $V_{OUT} = 0.5 V_{PP}$ , $R_L = 1\text{ k}\Omega$  |                 | 92              |                    | MHz            |
|  |   | $A_V = 2$ , $V_{OUT} = 0.5 V_{PP}$ , $R_L = 1\text{ k}\Omega$<br>$R_F = R_G = 750\Omega$                         |                 | 65              |                    |                |
|  |   | $A_V = 2$ , $V_{OUT} = 2 V_{PP}$ , $R_L = 150\Omega$ ,<br>$R_F = R_G = 680\Omega$                                |                 | 45              |                    |                |
| DG   | Differential Gain                         | $A_V = 2$ , 4.43 MHz, $0.6V < V_{OUT} < 2V$ ,<br>$R_L = 150\Omega$ to $V^+/2$                                    |                 | 0.05            |                    | %              |
| DP   | Differential Phase                        | $A_V = 2$ , 4.43 MHz, $0.6V < V_{OUT} < 2V$ ,<br>$R_L = 150\Omega$ to $V^+/2$                                    |                 | 0.05            |                    | deg            |
| <b>Time Domain Response</b>  |   |  |                 |                 |                    |                |
| $t_r/t_f$  | Rise & Fall Time                          | 2V Step, $A_V = 1$   |                 | 3.5             |                    | ns             |
| SR   | Slew Rate                                 | 2V Step, $A_V = 1$   |                 | 460             |                    | V/ $\mu s$     |
| $t_{s,0.1}$  | 0.1% Settling Time                        | 2V Step, $A_V = -1$  |                 | 60              |                    | ns             |
| $t_{s,0.01}$   | 0.01% Settling Time                       | 2V Step, $A_V = -1$  |                 | 100             |                    |                |
| <b>Noise and Distortion Performance</b>  |   |  |                 |                 |                    |                |
| SFDR   | Spurious Free Dynamic Range               | $f_C = 100\text{ kHz}$ , $A_V = 2$ , $V_{OUT} = 2 V_{PP}$  |                 | 102             |                    | dBc            |
|  |   | $f_C = 1\text{ MHz}$ , $A_V = 2$ , $V_{OUT} = 2 V_{PP}$  |                 | 100             |                    |                |
|  |   | $f_C = 5\text{ MHz}$ , $A_V = 2$ , $V_{OUT} = 2 V_{PP}$  |                 | 81              |                    |                |
| $e_n$  | Input Voltage Noise                       | $f = 100\text{ kHz}$   |                 | 10              |                    | $nV/\sqrt{Hz}$ |
| $i_n$  | Input Current Noise                       | $f = 100\text{ kHz}$   |                 | 2               |                    | $pA/\sqrt{Hz}$ |
| CT   | Crosstalk<br>(LMH6612)                    | $f = 5\text{ MHz}$ , $V_{IN} = 2 V_{PP}$   |                 | 71              |                    | dB             |

| Symbol                           | Parameter   | Condition   | Min<br>(Note 8) | Typ<br>(Note 7) | Max<br>(Note 8)                            | Units             |
|----------------------------------|---|---|-----------------|-----------------|--|-------------------|
| <b>Input DC Performance</b>      |   |   |                 |                 |  |                   |
| $V_{OS}$                         | Input Offset Voltage (LMH6611)                                  | $V_{CM} = -4.5V$  |                 | 0.074           | $\pm 0.600$<br><b><math>\pm 1.1</math></b> | mV                |
|                                  | Input Offset Voltage (LMH6612)                                  | $V_{CM} = -4.5V$  |                 | 0.095           | $\pm 0.750$<br><b><math>\pm 1.4</math></b> |                   |
| $TCV_{OS}$                       | Input Offset Voltage Average Drift                              | (Note 5)  |                 | 0.4             |  | $\mu V/^{\circ}C$ |
| $I_B$                            | Input Bias Current  | $V_{CM} = -4.5V$  |                 | -6.5            | -10.1<br><b>-11.1</b>                      | $\mu A$           |
| $I_O$                            | Input Offset Current  |   |                 | 0.01            | $\pm 0.5$<br><b><math>\pm 0.7</math></b>   | $\mu A$           |
| $C_{IN}$                         | Input Capacitance   |   |                 | 2.5             |  | pF                |
| $R_{IN}$                         | Input Resistance  |   |                 | 6               |  | $M\Omega$         |
| CMVR                             | Input Voltage Range   | DC, CMRR $\geq 81$ dB                                   | -5.2            |                 | 3.8  | V                 |
| CMRR                             | Common Mode Rejection Ratio                                     | $V_{CM}$ Stepped from -5.1V to 3.7V                     | 81              | 98              |  | dB                |
| $A_{OL}$                         | Open Loop Gain  | $R_L = 1\text{ k}\Omega$ , $V_{OUT} = +4.6V$ to $-4.6V$ | 96              | 103             |  | dB                |
|                                  |   | $R_L = 150\Omega$ , $V_{OUT} = +4.3V$ to $-4.3V$        | 80              | 87              |  |                   |
| <b>Output DC Characteristics</b> |   |   |                 |                 |  |                   |
| $V_O$                            | Output Swing High (LMH6611)<br>(Voltage from $V^+$ Supply Rail) | $R_L = 1\text{ k}\Omega$ to GND                         |                 | 107             | 125<br><b>130</b>                          | mV                |
|                                  |   | $R_L = 150\Omega$ to GND                                |                 | 339             | 402<br><b>433</b>                          |                   |
|                                  | Output Swing Low (LMH6611)<br>(Voltage from $V^-$ Supply Rail)  | $R_L = 1\text{ k}\Omega$ to GND                         |                 | 103             | 123<br><b>132</b>                          |                   |
|                                  |   | $R_L = 150\Omega$ to GND                                |                 | 332             | 404<br><b>445</b>                          |                   |
|                                  |   | $R_L = 150\Omega$ to $V^-$                              |                 | 54              | 70<br><b>74</b>                            |                   |
|                                  | Output Swing High (LMH6612)<br>(Voltage from $V^+$ Supply Rail) | $R_L = 1\text{ k}\Omega$ to GND                         |                 | 107             | 118<br><b>125</b>                          |                   |
|                                  |   | $R_L = 150\Omega$ to GND                                |                 | 340             | 375<br><b>407</b>                          |                   |
|                                  | Output Swing Low (LMH6612)<br>(Voltage from $V^-$ Supply Rail)  | $R_L = 1\text{ k}\Omega$ to GND                         |                 | 108             | 120<br><b>135</b>                          |                   |
|                                  |   | $R_L = 150\Omega$ to GND                                |                 | 348             | 389<br><b>434</b>                          |                   |
|                                  |   | $R_L = 150\Omega$ to $V^-$                              |                 | 56              | 66<br><b>74</b>                            |                   |
| $I_{OUT}$                        | Linear Output Current   | $V_{OUT} = \text{GND}$ (Note 6)                         |                 | $\pm 120$       |  | mA                |
| $R_O$                            | Output Resistance   | $f = 1\text{ MHz}$                                      |                 | 0.07            |  | $\Omega$          |
| <b>Enable Pin Operation</b>      |   |   |                 |                 |  |                   |
|                                  | Enable High Voltage Threshold                                   | Enabled (Note 9)  | 0.5             |                 |  | V                 |
|                                  | Enable Pin High Current   | $V_{DISABLE} = +5V$                                     |                 | 17.0            |  | $\mu A$           |
|                                  | Enable Low Voltage Threshold                                    | Disabled (Note 9)                                       |                 |                 | -0.5                                       | V                 |
|                                  | Enable Pin Low Current  | $V_{DISABLE} = -5V$                                     |                 | 18.6            |  | $\mu A$           |
| $t_{on}$                         | Turn-On Time  |   |                 | 19              |  | ns                |
| $t_{off}$                        | Turn-Off Time   |   |                 | 60              |  | ns                |

| Symbol                          | Parameter                                 | Condition                                    | Min<br>(Note 8) | Typ<br>(Note 7) | Max<br>(Note 8)     | Units   |
|---------------------------------|---|--|-----------------|-----------------|---------------------|---------|
| <b>Power Supply Performance</b> |   |  |                 |                 |                     |         |
| PSRR                            | Power Supply Rejection Ratio              | DC, $V_{CM} = -4.5V$ , $V_S = 2.7V$ to $11V$ | 81              | 96              |                     | dB      |
| $I_S$                           | Supply Current (LMH6611)                  | $R_L = \infty$                               |                 | 3.3             | 3.8<br><b>4.4</b>   | mA      |
|                                 | Supply Current (LMH6612)<br>(per channel) | $R_L = \infty$                               |                 | 3.45            | 4.05<br><b>4.85</b> |         |
| $I_{SD}$                        | Disable Shutdown Current<br>(LMH6611)     | $DISABLE = -5V$                              |                 | 160             | 212                 | $\mu A$ |

**Note 1:** Absolute Maximum Ratings indicate limits beyond which damage to the device may occur. Operating Ratings indicate conditions for which the device is intended to be functional, but specific performance is not guaranteed. For guaranteed specifications and the test conditions, see the Electrical Characteristics.

**Note 2:** Human Body Model, applicable std. MIL-STD-883, Method 3015.7. Machine Model, applicable std. JESD22-A115-A (ESD MM std. of JEDEC). Field-Induced Charge-Device Model, applicable std. JESD22-C101-C (ESD FICDM std. of JEDEC).

**Note 3:** The maximum power dissipation is a function of  $T_{J(MAX)}$ ,  $\theta_{JA}$ . The maximum allowable power dissipation at any ambient temperature is  $P_D = (T_{J(MAX)} - T_A) / \theta_{JA}$ . All numbers apply for packages soldered directly onto a PC Board.

**Note 4:** Boldface limits apply to temperature range of  $-40^\circ C$  to  $125^\circ C$

**Note 5:** Voltage average drift is determined by dividing the change in  $V_{OS}$  by temperature change.

**Note 6:** Do not short circuit the output. Continuous source or sink currents larger than the  $I_{OUT}$  typical are not recommended as they may damage the part.

**Note 7:** Typical values represent the most likely parametric norm as determined at the time of characterization. Actual typical values may vary over time and will also depend on the application and configuration. The typical values are not tested and are not guaranteed on shipped production material.

**Note 8:** Limits are 100% production tested at  $25^\circ C$ . Limits over the operating temperature range are guaranteed through correlations using the Statistical Quality Control (SQC) method.

**Note 9:** This parameter is guaranteed by design and/or characterization and is not tested in production.

## Connection Diagrams

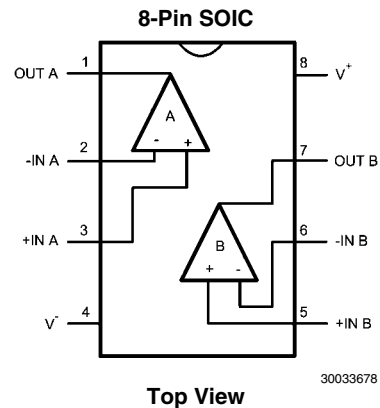
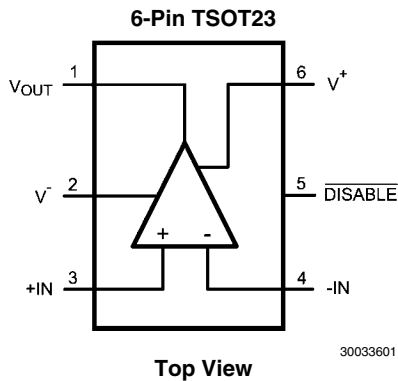

## Ordering Information

| Package      | Part Number | Package Marking | Transport Media          | NSC Drawing |
|--------------|-------------|-----------------|--------------------------|-------------|
| 6-Pin TSOT23 | LMH6611MK   | AX4A            | 1k Units Tape and Reel   | MK06A       |
|              | LMH6611MKE  |                 | 250 Units Tape and Reel  |             |
|              | LMH6611MKX  |                 | 3k Units Tape and Reel   |             |
| 8-Pin SOIC   | LMH6612MA   | LMH6612MA       | 95 Rail/Units            | M08A        |
|              | LMH6612MAX  |                 | 2.5k Units Tape and Reel |             |



**Typical Performance Characteristics** At  $T_J = 25^\circ\text{C}$ ,  $A_V = +1$  ( $R_F = 0\Omega$ ), otherwise  $R_F = 560\Omega$  for  $A_V \neq +1$ , unless otherwise specified.

**Closed Loop Frequency Response for Various Supplies**

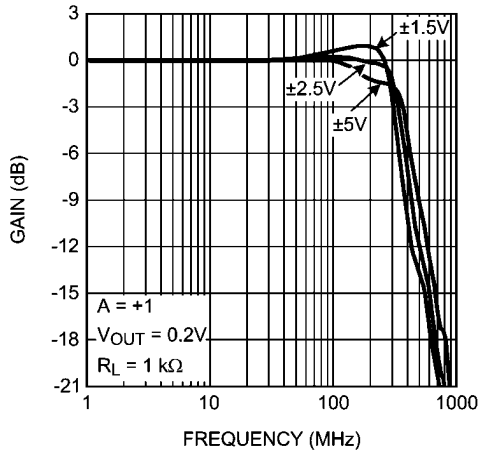

30033625

**Closed Loop Frequency Response for Various Supplies**

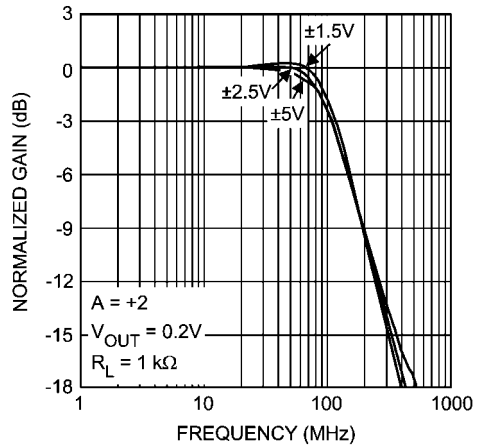

30033624

**Closed Loop Frequency Response for Various Supplies**

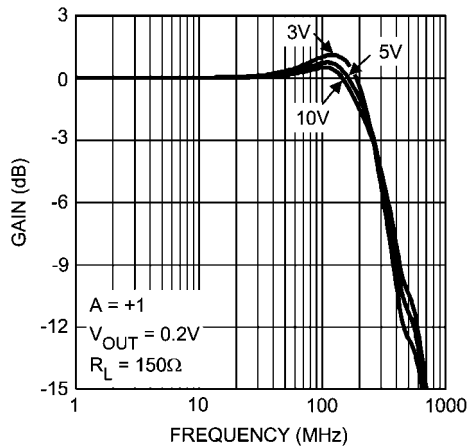

30033604

**Closed Loop Frequency Response for Various Supplies (Gain = +2)**

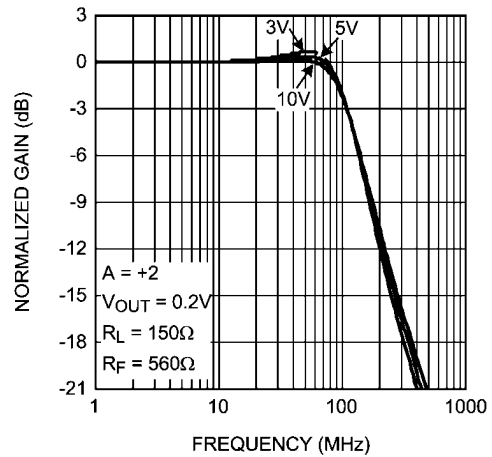

30033605

**Closed Loop Gain vs. Frequency for Various Temperatures**

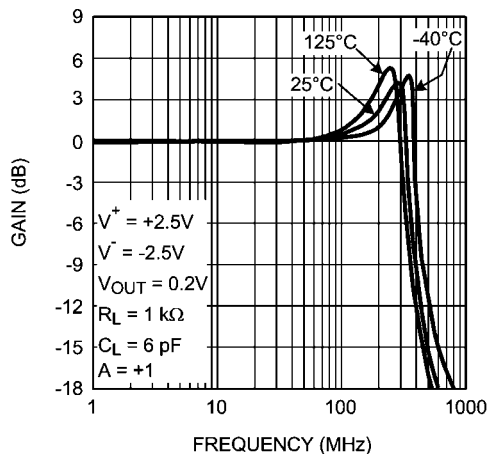

30033654

**Closed Loop Gain vs. Frequency for Various Temperatures**

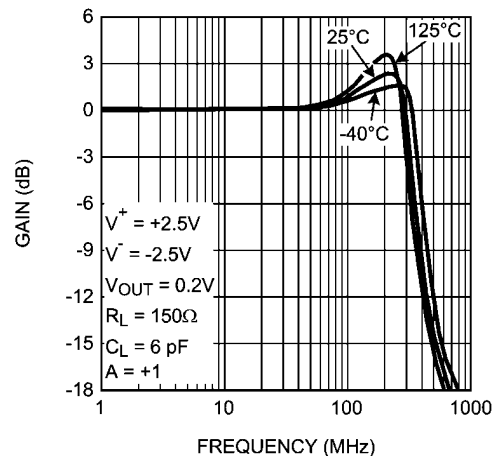

30033655

**Closed Loop Gain vs. Frequency for Various Gains**

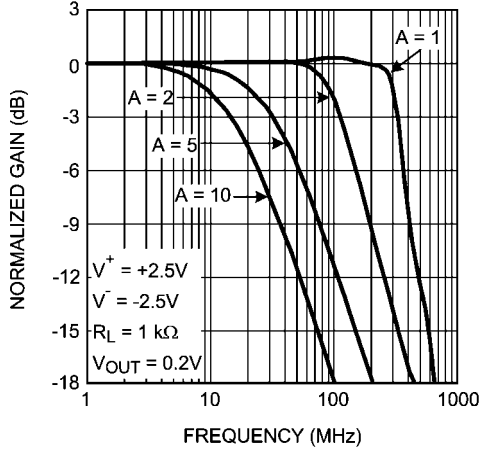

30033623

**Large Signal Frequency Response**

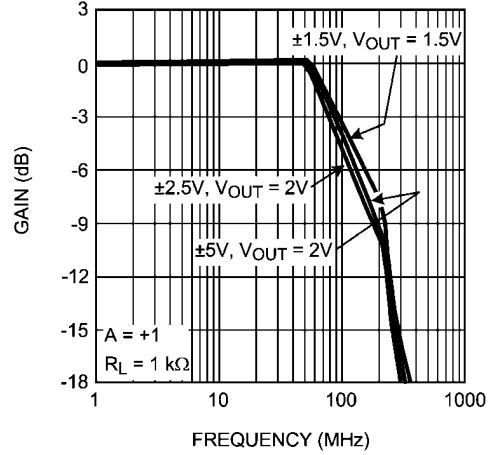

30033630

**Large Signal Frequency Response**

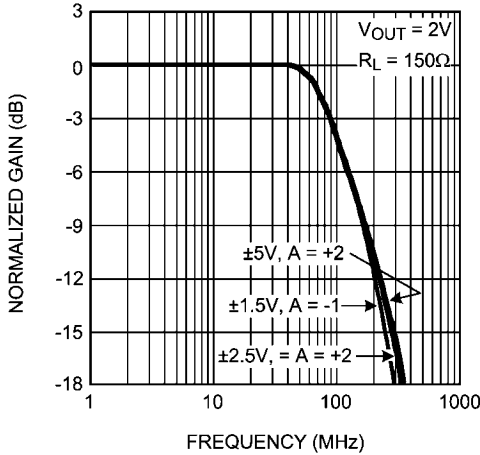

30033631

**$\pm 0.1$  dB Gain Flatness for Various Supplies**

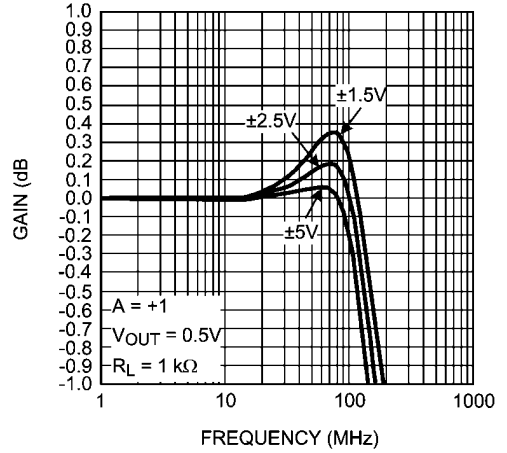

30033626

**$\pm 0.1$  dB Gain Flatness for Various Supplies**

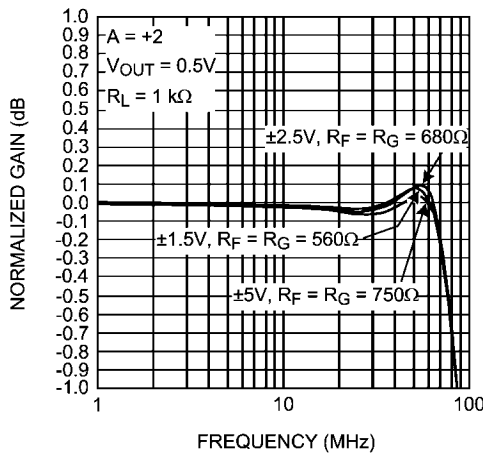

30033627

**$\pm 0.1$  dB Gain Flatness for Various Supplies**

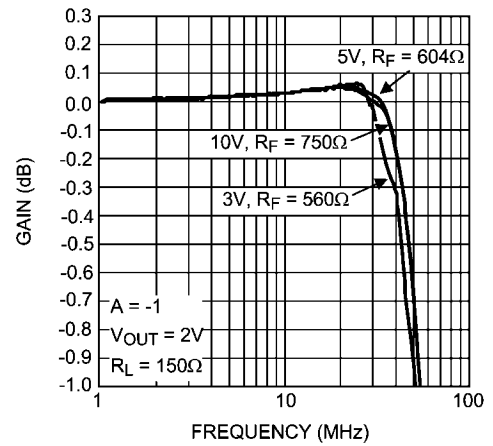

30033606

±0.1 dB Gain Flatness for Various Supplies

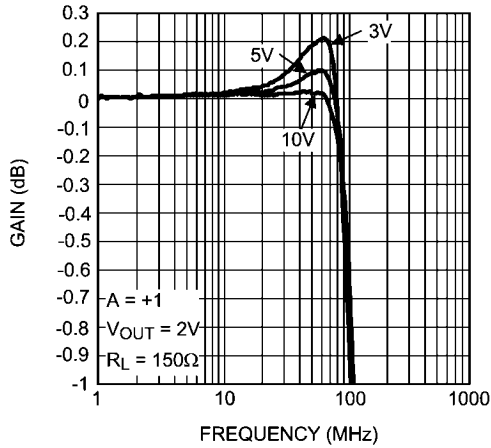

30033607

±0.1 dB Gain Flatness for Various Supplies (Gain = +2)

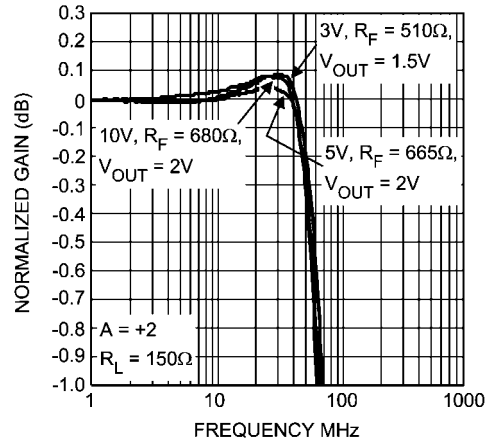

30033675

Small Signal Frequency Response with Various Capacitive Load

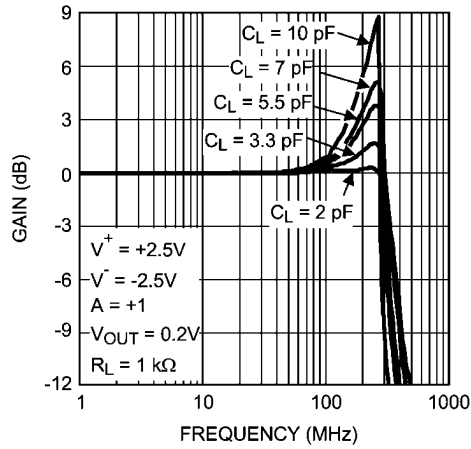

30033608

Small Signal Frequency Response with Capacitive Load and Various RISO

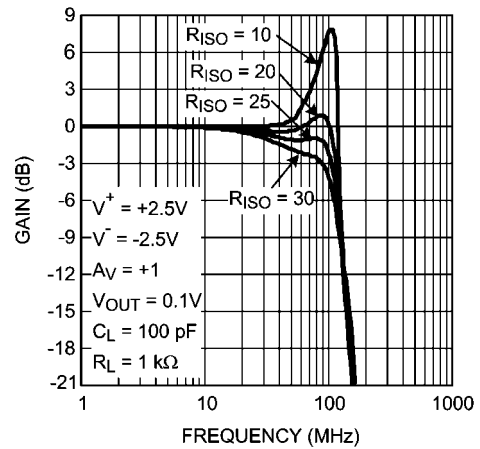

30033609

HD2 and HD3 vs. Frequency and Supply Voltage

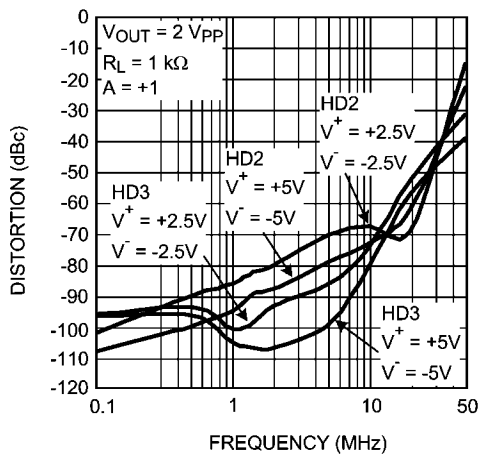

30033653

HD2 and HD3 vs. Frequency and Load

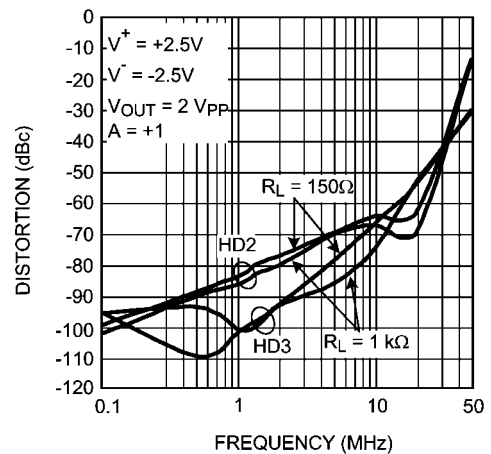

30033650

HD2 and HD3 vs. Common Mode Voltage

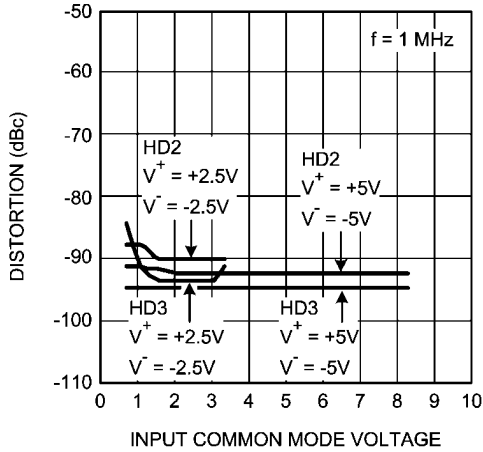

30033677

HD2 and HD3 vs. Common Mode Voltage

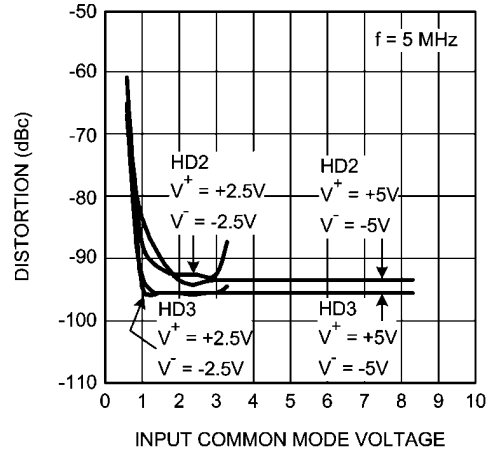

30033681

HD2 vs. Frequency and Gain

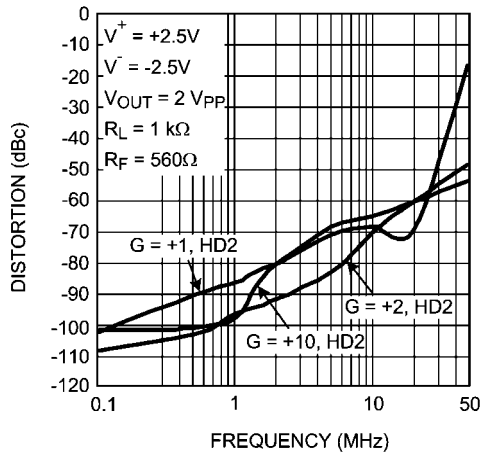

30033651

HD3 vs. Frequency and Gain

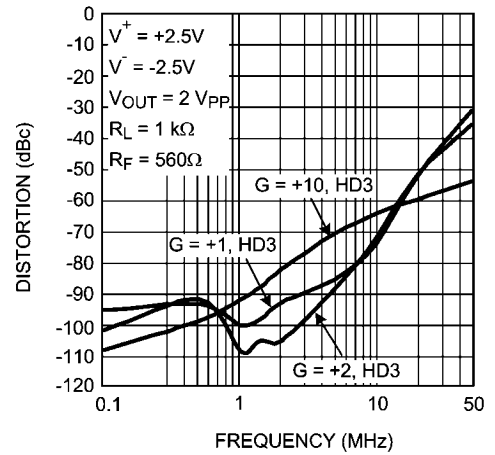

30033652

Open Loop Gain and Phase

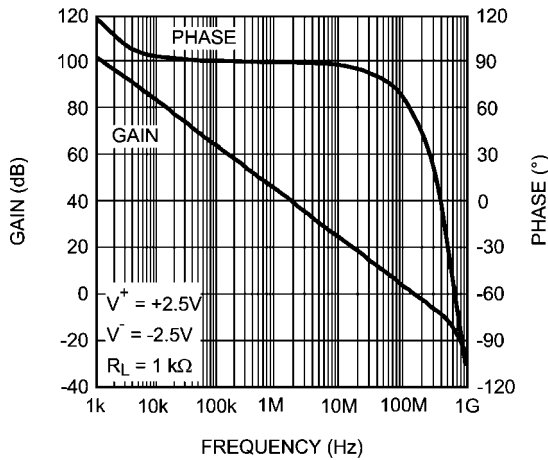

30033676

HD2 vs. Output Swing

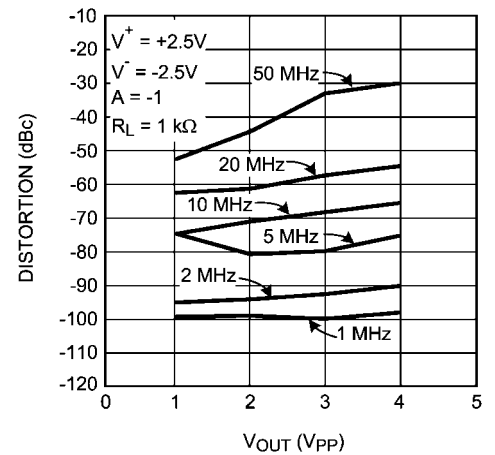

30033682

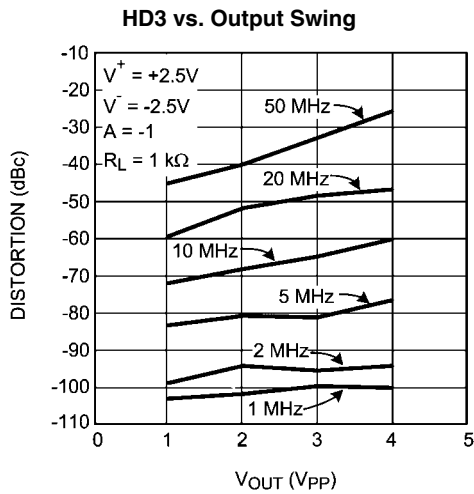

30033683

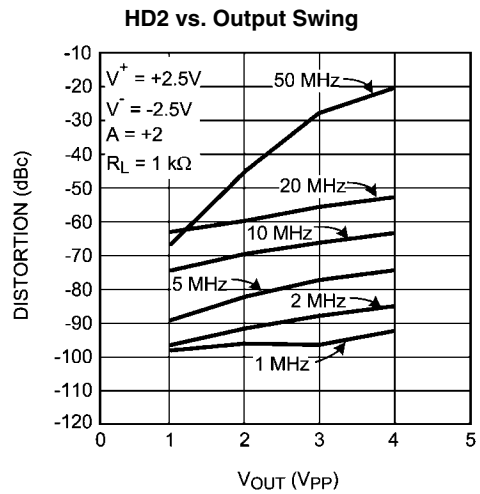

30033693

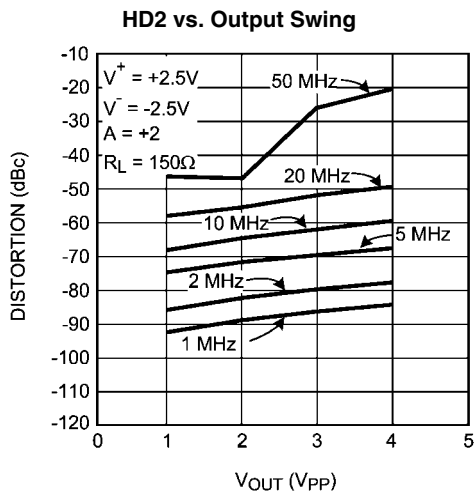

30033694

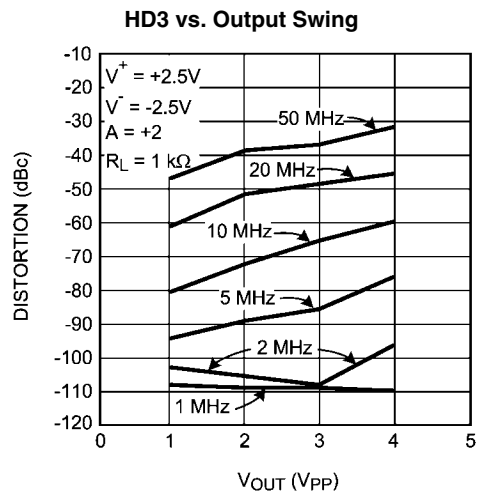

30033684

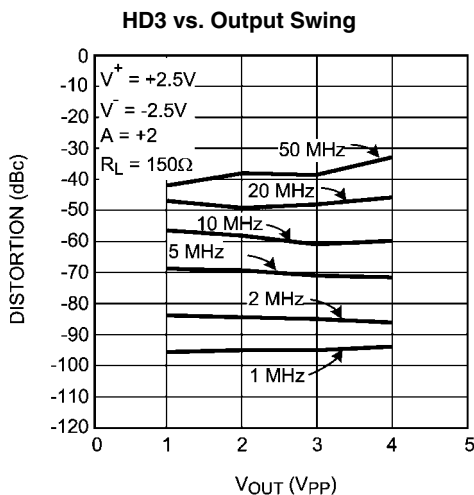

30033685

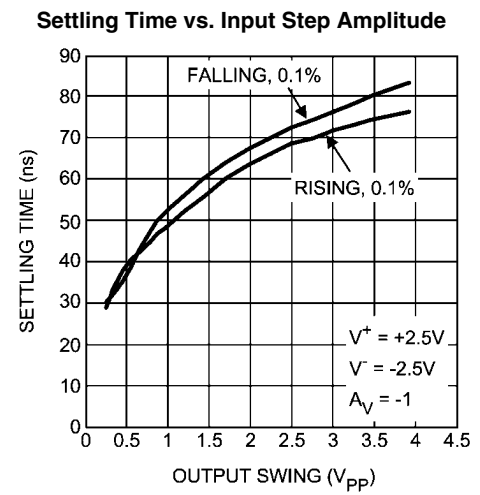

30033686

Settling Time vs. Input Step Amplitude

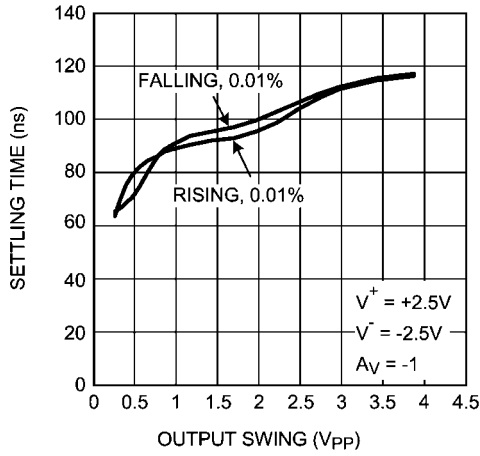

30033687

Input Noise vs. Frequency

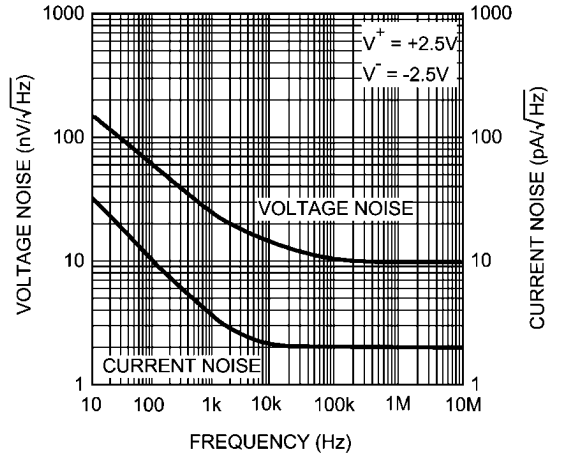

30033674

$V_{OS}$  vs.  $V_{OUT}$

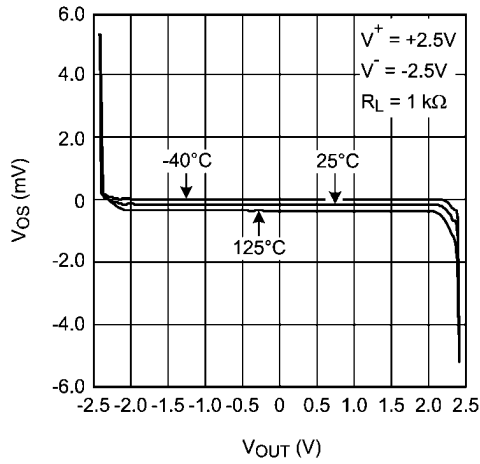

30033661

$V_{OS}$  vs.  $V_{OUT}$

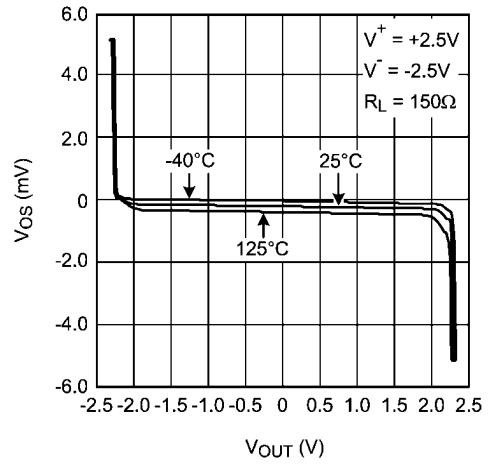

30033668

$V_{OS}$  vs.  $V_{CM}$

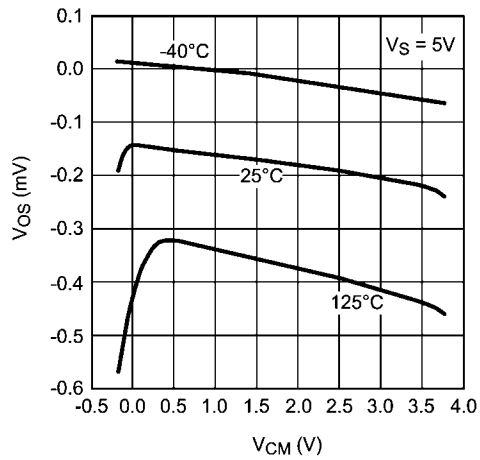

30033660

$V_{OS}$  vs.  $V_S$

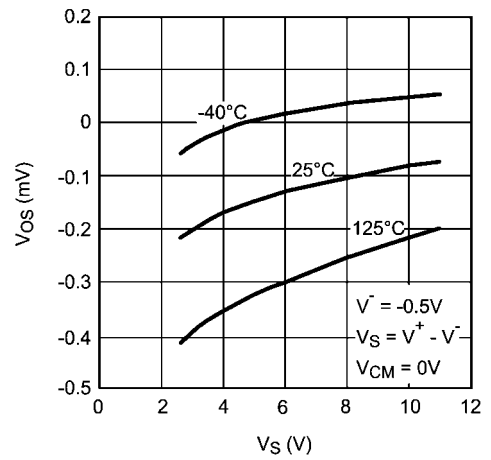

30033658

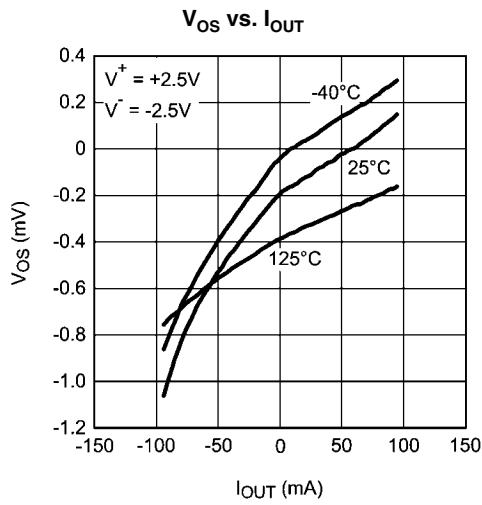

30033669

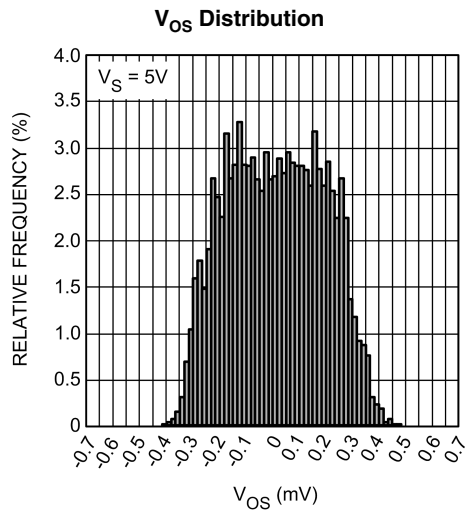

30033672

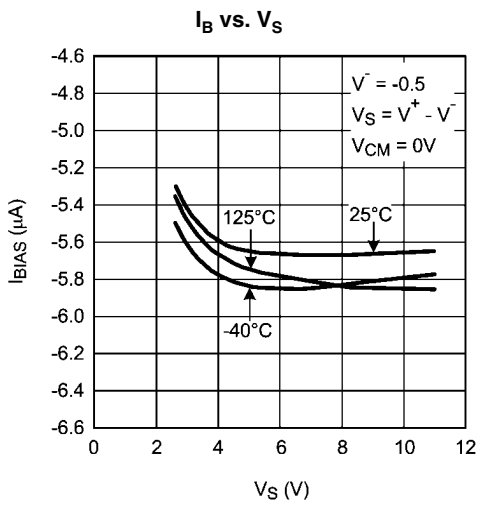

30033659

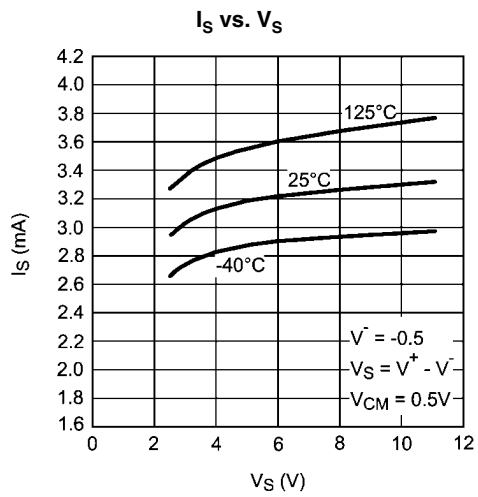

30033657

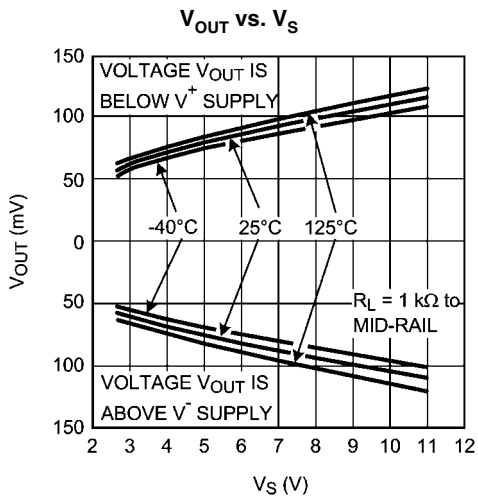

30033690

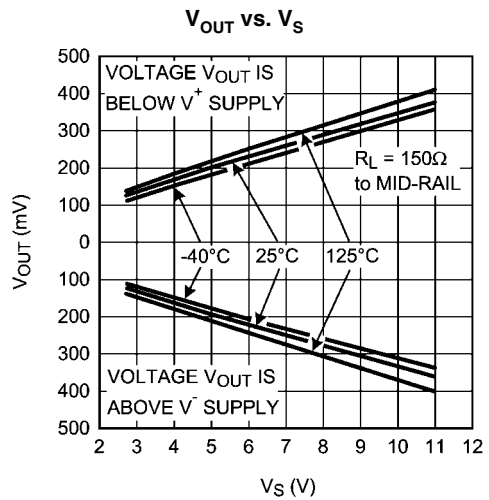

30033691

$V_{OUT}$  vs.  $V_S$

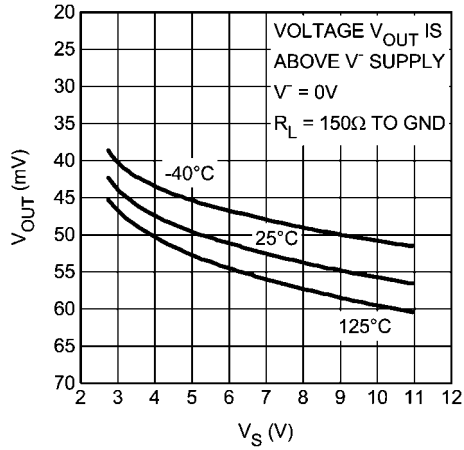

30033671

Closed Loop Output Impedance vs. Frequency  $A_V = +1$

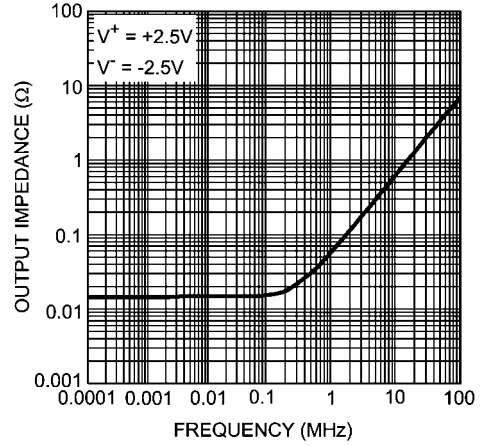

30033696

Circuit for Positive (+) PSRR Measurement

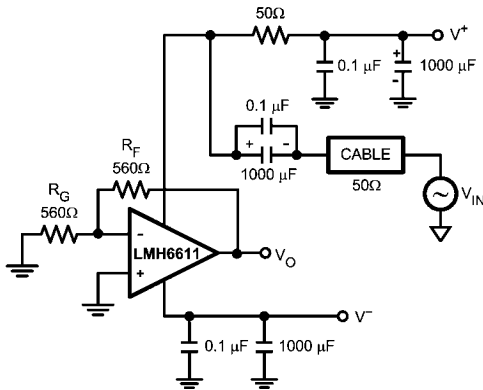

30033688

+PSRR vs. Frequency

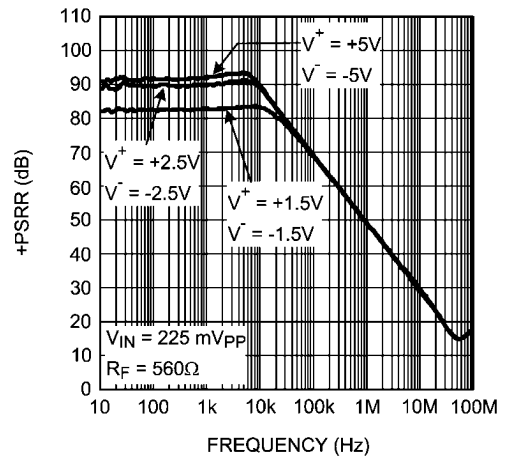

30033633

Circuit for Negative (-) PSRR Measurement

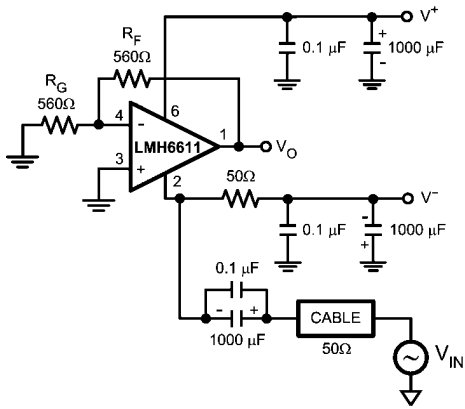

30033689

-PSRR vs. Frequency

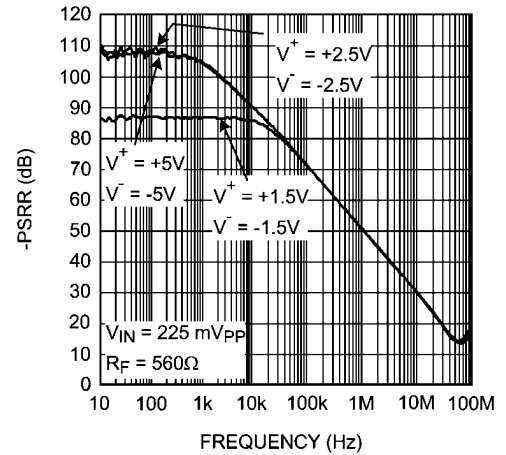

30033634



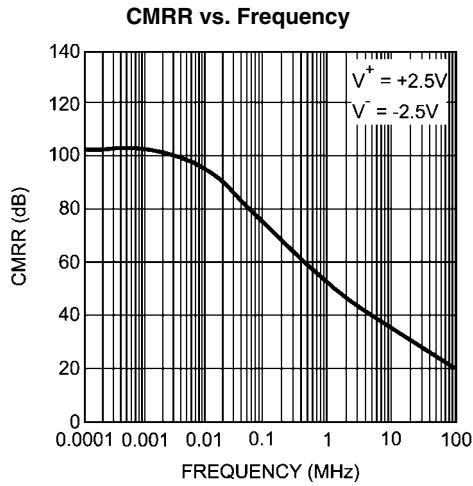

30033697

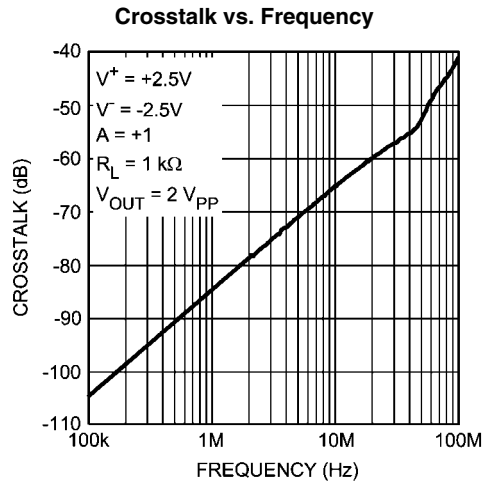

30033632

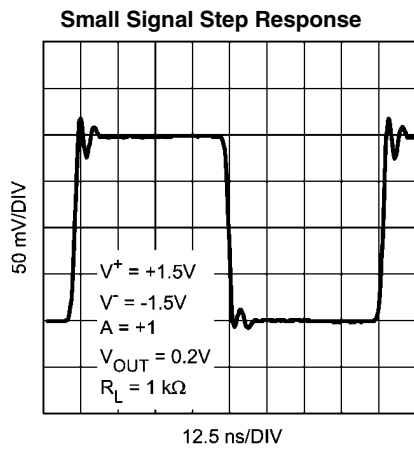

30033610

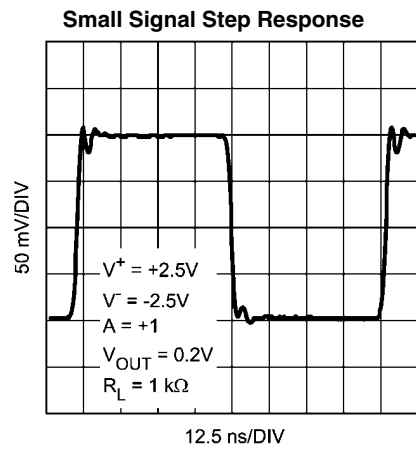

30033611

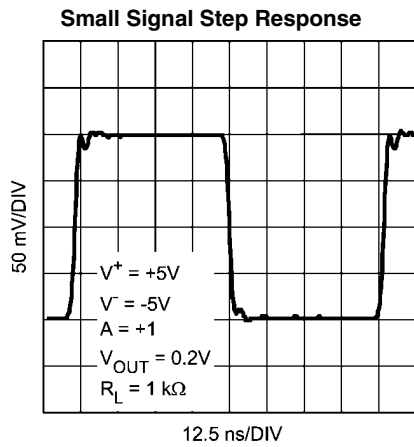

30033612

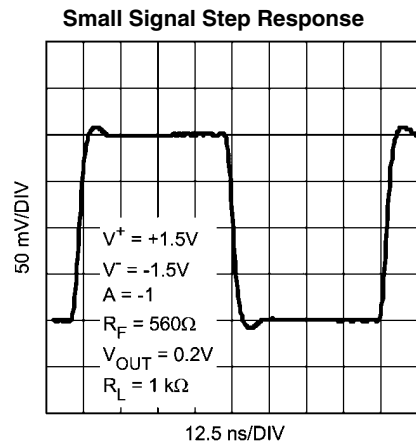

30033614

Small Signal Step Response

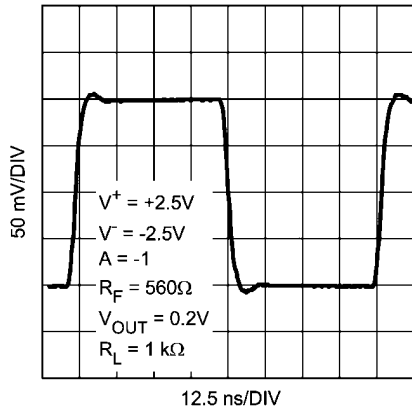

Small Signal Step Response

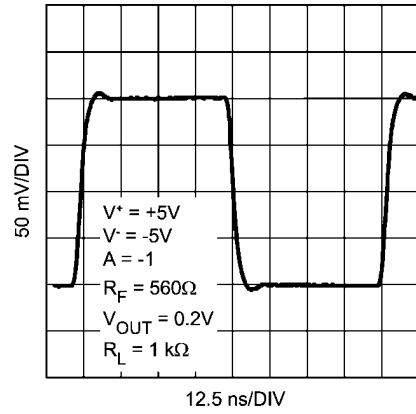

Small Signal Step Response

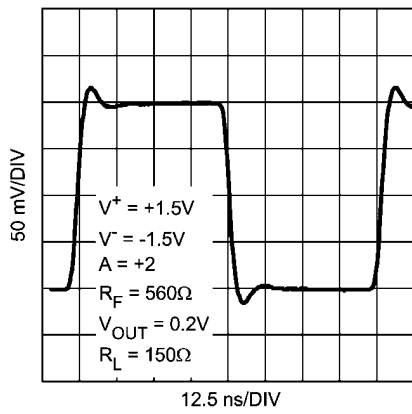

Small Signal Step Response

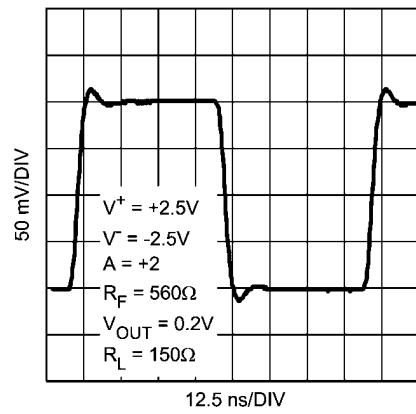

Small Signal Step Response

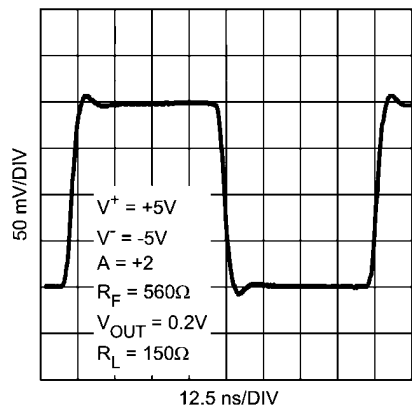

Large Signal Step Response

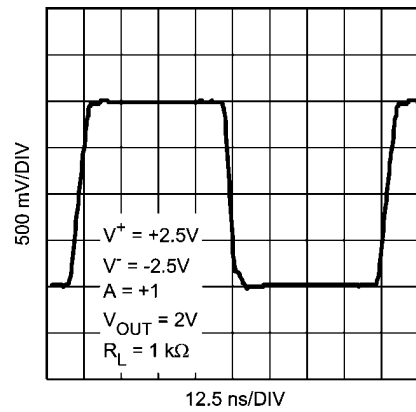

Large Signal Step Response

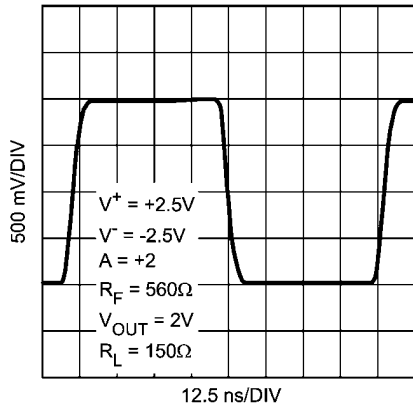

30033620

Overload Recovery Response

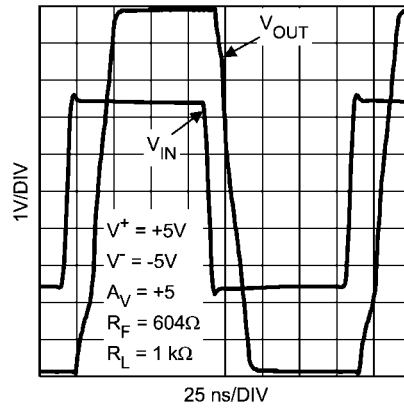

30033621

$I_S$  vs.  $V_{DISABLE}$

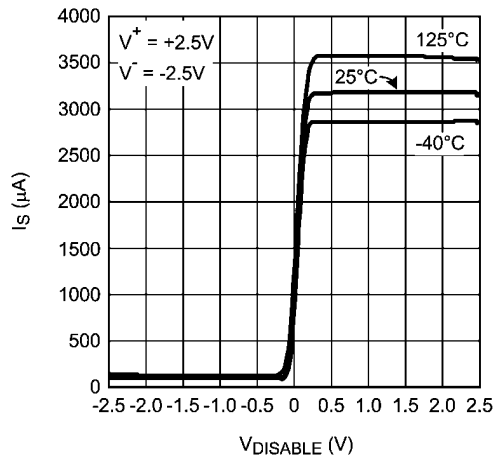

30033656

## Application Information

The LMH6611 and LMH6612 are based on National Semiconductor's proprietary VIP10 dielectrically isolated bipolar process. This device family architecture features the following:

- Complimentary bipolar devices with exceptionally high  $f_t$  (~8 GHz) even under low supply voltage (2.7V) and low bias current.
- Common emitter push-push output stage. This architecture allows the output to reach within millivolts of either supply rail.
- Consistent performance with little variation from any supply voltage (2.7V - 11V) for the most important specifications (e.g. BW, SR,  $I_{OUT}$ .)
- Significant power saving compared to competitive devices on the market with similar performance.

With 3V supplies and a common mode input voltage range that extends beyond either supply rail, the LMH6611 is well suited to many low voltage/low power applications. Even with 3V supplies, the -3 dB BW (at  $A_V = +1$ ) is typically 305 MHz. The LMH6611 and LMH6612 are designed to avoid output phase reversal. With input overdrive, the output is kept near the supply rail (or as close to it as mandated by the closed loop gain setting and the input voltage). *Figure 1* shows the input and output voltage when the input voltage significantly exceeds the supply voltages.

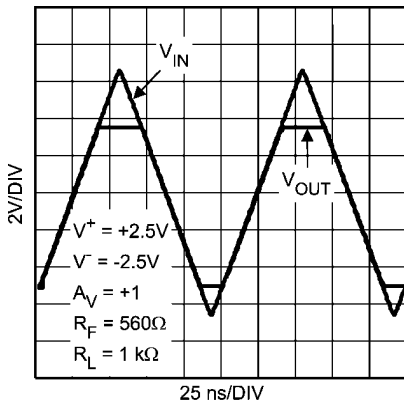

30033622

**FIGURE 1. Input and Output Shown with CMVR Exceeded**

If the input voltage range is exceeded by more than a diode drop beyond either rail, the internal ESD protection diodes will start to conduct. The current flow in these ESD diodes should be externally limited.

### SHUTDOWN CAPABILITY AND TURN ON/OFF BEHAVIOR

The LMH6611 can be shutdown by connecting the  $\overline{\text{DISABLE}}$  pin to a voltage 0.5V below the supply midpoint which will reduce the supply current to typically 120  $\mu\text{A}$ . The  $\overline{\text{DISABLE}}$  pin is "active low" and can be connected through a resistor to  $V^+$  or left floating for normal operation. Shutdown is guaranteed when the  $\overline{\text{DISABLE}}$  pin is 0.5V below the supply midpoint at any operating supply voltage and temperature. Typical turn on time is 20 ns and the turn off time is 60 ns.

In the shutdown mode, essentially all internal device biasing is turned off in order to minimize supply current flow and the output goes into high impedance mode. During shutdown, the input stage has an equivalent circuit as shown in *Figure 2*.

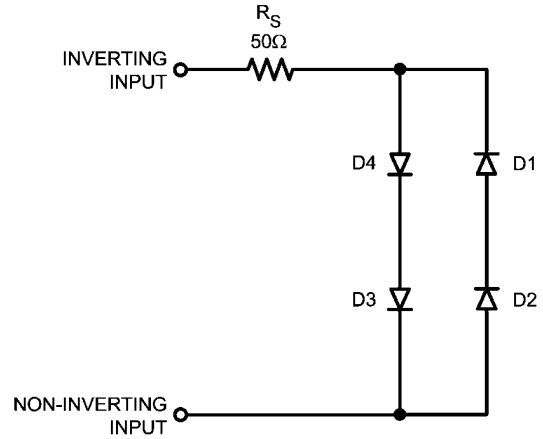

30033639

**FIGURE 2. Input Equivalent Circuit During Shutdown**

When the LMH6611 is shutdown, there may be current flow through the internal diodes shown, caused by input potential, if present. This current may flow through the external feedback resistor and result in an apparent output signal. In most shutdown applications the presence of this output is inconsequential. However, if the output is "forced" by another device, the other device will need to conduct the current described in order to maintain the output potential.

To keep the output at or near ground during shutdown when there is no other device to hold the output low, a switch using a transistor can be used to shunt the output to ground.

### SELECTION OF $R_F$ AND EFFECT ON STABILITY AND PEAKING

The peaking of the LMH6611 depends on the value of the  $R_F$ . From the graph shown in *Figure 3*, as the  $R_F$  value increases, the peaking increases.

For  $A_V = 2$ , at  $R_F = 1 \text{ k}\Omega$ , the -3 dB bandwidth is 113 MHz and peaking is about 0.6 dB whereas at  $R_F = 665\Omega$ , the -3 dB bandwidth is about 110 MHz and peaking is 0 dB.  $R_F$  and the input capacitance form a pole in the amplifier's response. If the time constant is too big, it will cause peaking and ringing. Except for  $A_V = 1$  when  $R_F$  should be  $0\Omega$ , across all other gain settings it is recommended that  $R_F$  remain between  $500\Omega$  and  $1 \text{ k}\Omega$  to ensure optimum performance.

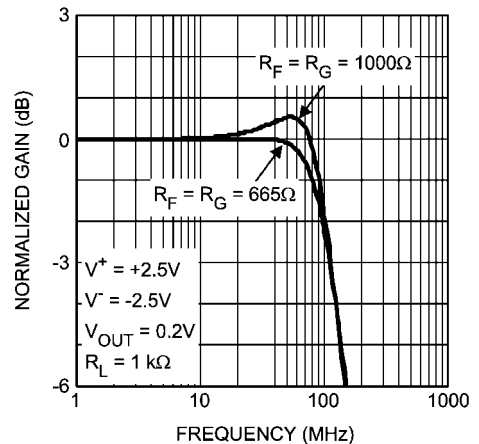

30033692

**FIGURE 3. Closed Loop Gain vs. Frequency and  $R_F = R_G$**

| $R_F = R_G$ | f -3 dB (MHz) | Peaking (dB) |
|-------------|---------------|--------------|
| 665         | 110           | 0            |
| 1000        | 113           | 0.6          |

### MINIMIZING NOISE

With a low input voltage noise of  $10 \text{ nV}/\sqrt{\text{Hz}}$  and an input current noise of  $2 \text{ pA}/\sqrt{\text{Hz}}$  the LMH6611 and LMH6612 are suitable for high accuracy applications. Still being able to reduce the frequency band of operation of the various noise sources (i.e. op amp noise voltage, resistor thermal noise, input noise current) can further improve the noise performance of a system. In a non-inverting amplifier configuration inserting a capacitor,  $C_G$ , in series with the gain setting resistor,  $R_G$ , will reduce the gain of the circuit below frequency,  $f = 1/2\pi R_G C_G$ . This can be set to reduce the contribution of noise from the  $1/f$  region. Alternatively applying a feedback capacitor,  $C_F$ , in parallel with the feedback resistor,  $R_F$ , will introduce a pole into your system at  $f = 1/2\pi R_F C_F$  and create a low pass filter. This filter can be set to reduce high frequency noise and harmonics. Finally remember to keep resistor values as small as possible for a given application in order to reduce resistor thermal noise.

### POWER SUPPLY BYPASS

Since the LMH6611 and LMH6612 are wide bandwidth amplifiers, proper power supply bypassing is critical for optimum performance. Improper power supply bypassing can result in large overshoot, ringing or oscillation.  $0.1 \mu\text{F}$  capacitors should be connected from the supply pins,  $V^+$  and  $V^-$ , to ground, as close to the device as is practical. Additionally, a  $10 \mu\text{F}$  electrolytic capacitor should be connected from both supply pins to ground reasonably close to the device. Finally, near the device a  $0.1 \mu\text{F}$  ceramic capacitor between the supplies will provide the best harmonic distortion performance.

### INTERFACING HIGH PERFORMANCE OP AMPS WITH ADCs

These amplifiers are designed for ease of use in a wide range of applications requiring high speed, low supply current, low noise, and the ability to drive complex ADC and video loads.

The source that drives the modern high resolution analog-to-digital converters (ADCs) sees a high frequency AC load and a DC load of a few hundred ohms or more. Thus, a high performance op amp with high input impedance of a few mega ohms and low output impedance would be an ideal choice as an input ADC driver. The LMH6611/LMH6612 have the low output impedance of  $0.07 \Omega$  at  $f = 1 \text{ MHz}$ . The ADC driver acts as a buffer and a low pass filter to reduce the overall system noise. To utilize the full dynamic range of the ADC, the ADC input has to be driven to full scale input voltage.

As signals travel through the traces of a printed circuit board (PCB) and long cables, system noise accumulates in the signals and a differential ADC rejects any signals noise that appears as a common mode voltage. There are a couple of advantages to using differential signals rather than single-ended signals. First, differential signals double the dynamic range of the ADC and second, they offer better harmonic distortion performance. There are several ways to produce differential signals from a dual op amp configuration. One method is to utilize the single-ended to differential conversion technique and the other is the differential to differential conversion technique. The first method requires a single input source and the second method requires differential input source.

A real world input source can have non-ideal impedance thus the buffer amplifier, with very low output impedance, is re-

quired to drive the input of the ADC. To minimize the droop in the input voltage, external shunt capacitance ( $C_L$ ) should be about ten times larger than the internal input capacitance of the ADC and external series resistance ( $R_L$ ) should be large enough to maintain the phase delay at the output of the op amp and hence maintain the stability (See Figure 4). Most applications benefit from the inclusion of a series isolation resistor connected between the op amp output and ADC input. This series resistor helps to limit the output current of the op amp. The value chosen for this series resistor is very important, as a higher value will increase the load impedance seen by the op amp and improve the total harmonic distortion (THD) performance of the op amp; however, the ADC prefers a low impedance source driving it. Thus, the optimum value for this series resistor must be found so that it will offer the best performance in terms of THD, SNR and SFDR of the combined op amp and ADC.

### Important Specifications of Op Amp and ADC

When interfacing an ADC with an op amp it is imperative to understand the specifications that are important to get the expected performance results. Modern ADC AC specifications such as THD, SNR, settling time and SFDR are critical for filtering, test and measurement, video and reconstruction applications. The high performance op amp's settling time, THD, and noise performance must be better than that of the ADC it is driving to maintain the proper system accuracy with minimal or no error.

Some system applications require low THD, low SFDR and wide dynamic range (SNR), whereas some system applications require high SNR and they may sacrifice THD and SFDR to focus on the noise performance.

Noise is a very important specification for both the op amp and the ADC. There are three main sources of noise that contribute to the overall performance of the ADC: Quantization noise, noise generated by the ADC itself (particularly at higher frequencies) and the noise generated by the application circuit. The impedance of the input source affects the noise performance of the op amp. Theoretically, an ADC's signal to noise ratio (SNR) can be found from the equation:

$$\text{SNR (in dB)} = 6.02 * N + 1.72$$

where N is the resolution of the ADC. For example, according to this equation a 12-bit ADC has an SNR of 74 dB. However, the practical SNR number would be about 72 dB. In order to achieve better SNR, the ADC driver noise should be as small as possible. The LMH6611/LMH6612 have the low voltage noise of only  $10 \text{ nV}/\sqrt{\text{Hz}}$ .

The combined settling time of the op amp and the ADC must be within 1 LSB. The 0.01% settling time of the LMH6611/LMH6612 is 100 ns.

The ADC driver's THD should be inherently lower than that of the ADC. The LMH6611/LMH6612 have an SFDR of 96 dBc at  $2 V_{PP}$  output and 1 MHz input frequency.

Signal to Noise and Distortion (SINAD) is a parameter which is the combination of the SNR and THD specifications. SINAD is defined as the RMS value of the output signal to the RMS value of all of the other spectral components below half the clock frequency, including harmonics but excluding DC. It can be calculated from SNR and THD according to the equation:

$$\text{SINAD} = 20 * \text{LOG} \sqrt{10^{-\frac{\text{SNR}}{10}} + 10^{-\frac{\text{THD}}{10}}}$$

Because SINAD compares all undesired frequency components with the input frequency, it is an overall measure of an ADC's dynamic performance. The following sections will discuss the three different ADC driver architectures in detail.

**SINGLE TO SINGLE ADC DRIVER**

This architecture has a single-ended input source connected to the input of the op amp and the single-ended output of the op amp is then fed to the single-ended input of the ADC. The low noise of only 10 nV/√Hz and a wide bandwidth of 345 MHz make the LMH6611 an excellent choice for driving the 12-bit ADC121S101 500 KSPS to 1 MSPS ADC, which has a successive approximation architecture with internal sample and hold circuits. Figure 2 shows the schematic of the LMH6611 in a 2nd order multiple-feedback with gain of -1 (inverting) configuration, driving an ADC121S101. The inverting configuration

is preferred over the non-inverting configuration, as it offers more linear output response. Table 1 shows the performance data of the LMH6611 combined with the ADC121S101. The ADC driver's cutoff frequency of 500 kHz is found from the equation:

$$f_0 = \frac{1}{2\pi} \times \sqrt{\frac{1}{R_2 \times R_5 \times C_2 \times C_5}}$$

The op amp's gain is set by the equation:

$$\text{GAIN} = - \frac{R_2}{R_1}$$

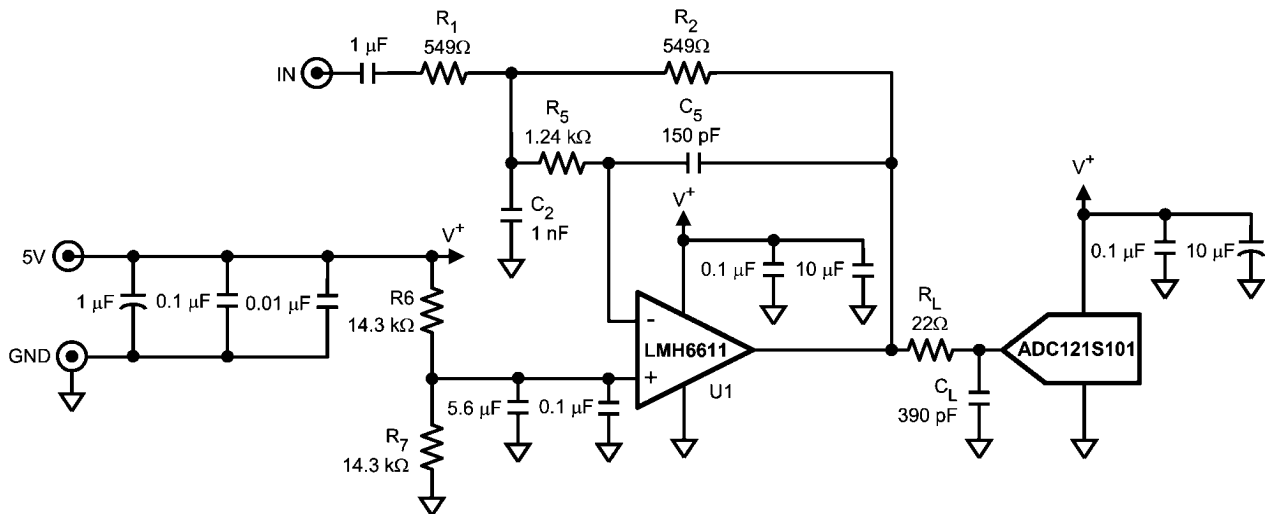

30033629

**FIGURE 4. Single to Single ADC Driver**

**TABLE 1. Performance of the LMH6611 Combined with the ADC121S101**

| Amplifier Output/ADC Input | SINAD | SNR  | THD   | SFDR  | ENOB | Notes                    |
|----------------------------|-------|------|-------|-------|------|--------------------------|
|                            | (dB)  | (dB) | (dB)  | (dBc) |      |                          |
| 4                          | 70.2  | 71.6 | -75.7 | 77.6  | 11.4 | ADC121S101 @ f = 200 kHz |

When the op amp and the ADC are using the same supply, it is important that both devices are well bypassed. A 0.1 μF ceramic capacitor and a 10 μF tantalum capacitor should be located as close as possible to each supply pin. A sample layout is shown in Figure 5. The 0.1 μF capacitors (C13 and C6) and the 10 μF capacitors (C11 and C5) are located very close to the supply pins of the LMH6611 and the ADC121S101.

The following are recommendations for the design of PCB layout in order to obtain the optimum high frequency performance:

- Place ADC and amplifier as close together as possible.
- Put the supply bypassing capacitors as close as possible to the device (<1").
- Utilize surface mount instead of through-hole components and ground and power planes.
- Keep the traces short where possible.
- Use terminated transmission lines for long traces.

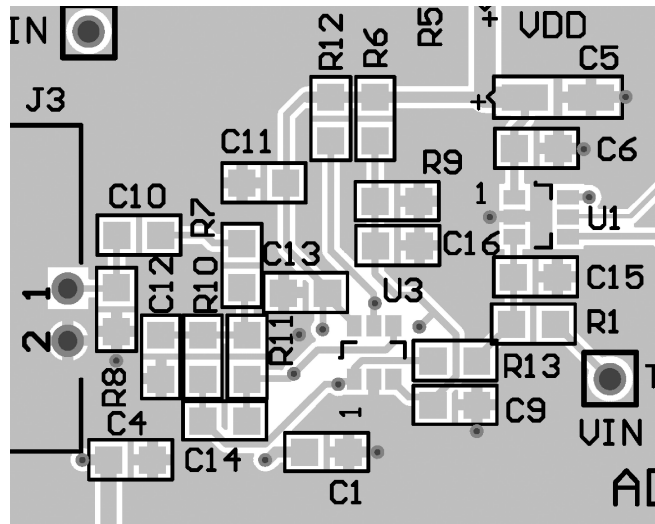

30033640

FIGURE 5. LMH6611 and ADC121S101 Layout

**SINGLE-ENDED TO DIFFERENTIAL ADC DRIVER**

The single-ended to differential ADC driver in Figure 3 utilizes an LMH6612 dual op amp to buffer a single-ended source to drive an ADC with differential inputs. One of the op amps is configured as a unity gain buffer that drives the inverting (IN-) input of the op amp U2 and non-inverting (IN+) input of the ADC121S625. U2 inverts the input signal and drives the inverting input of the ADC121S625. The ADC driver is configured for a gain of +2 to reduce the noise without sacrificing THD performance. The common mode voltage of 2.5V is set

up at the non-inverting inputs of both op amps U1 and U2. This configuration produces differential  $\pm 2.5 V_{PP}$  output signals, when the single-ended input signal of 0 to  $V_{REF}$  is AC coupled into the non-inverting terminal of the op amp and each non-inverting terminal of the op amp is biased at the mid-scale of 2.5V. The two output RC anti-aliasing filters are used between both the outputs of U1 and U2 and the input of the ADC121S625 to minimize the effect of undesired high frequency noise coming from the input source. Each RC filter has the cutoff frequency of approximately 22 MHz.

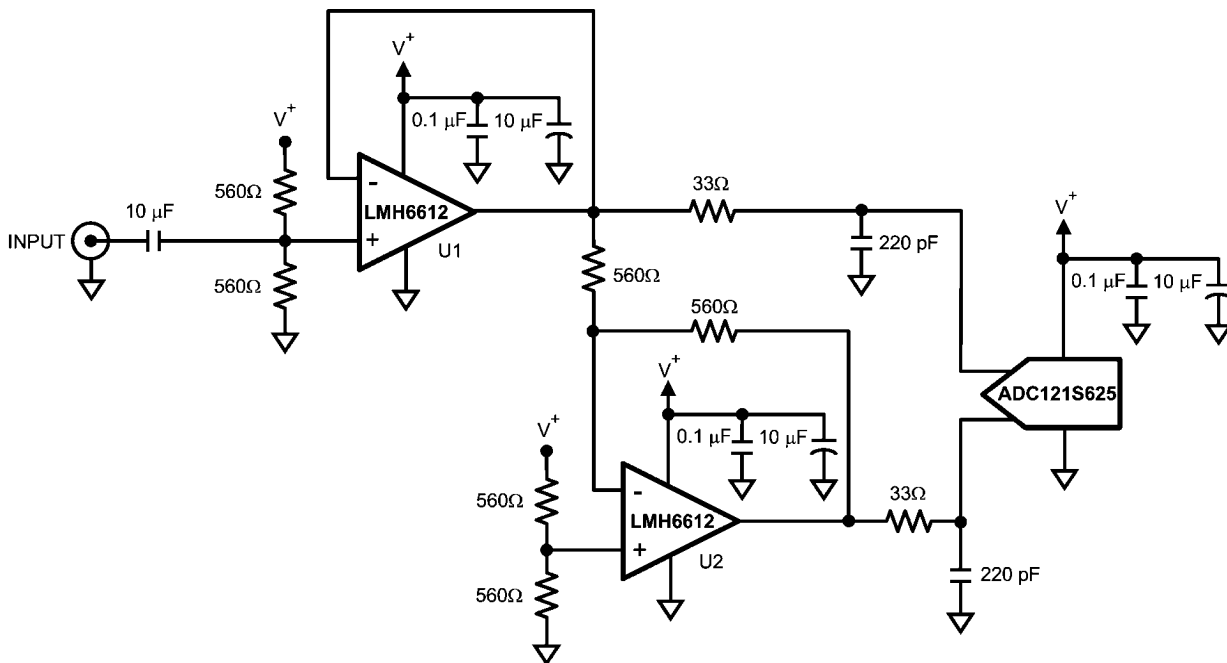

30033680

FIGURE 6. Single-Ended to Differential ADC Driver

The performance of the LMH6612 with the ADC121S625 is shown in *Table 2*.

**TABLE 2. Performance of the LMH6612 Combined with the ADC121S625**

| Amplifier Output/ADC Input | SINAD | SNR  | THD   | SFDR  | ENOB | Notes                   |
|----------------------------|-------|------|-------|-------|------|-------------------------|
|                            | (dB)  | (dB) | (dB)  | (dBc) |      |                         |
| 2.5                        | 68.8  | 69   | -81.5 | 75.1  | 11.2 | ADC121S625 @ f = 20 kHz |

**DIFFERENTIAL TO DIFFERENTIAL ADC DRIVER**

The LMH6612 dual op amp can be configured as a differential to differential ADC driver to buffer a differential source to a differential input ADC as shown in *Figure 7*. The differential to differential ADC driver can be formed using two single to

single ADC drivers. Each output from these drivers goes to a separate input of the differential ADC. Here, each single to single ADC driver uses the same components and is configured for a gain of -1 (inverting).

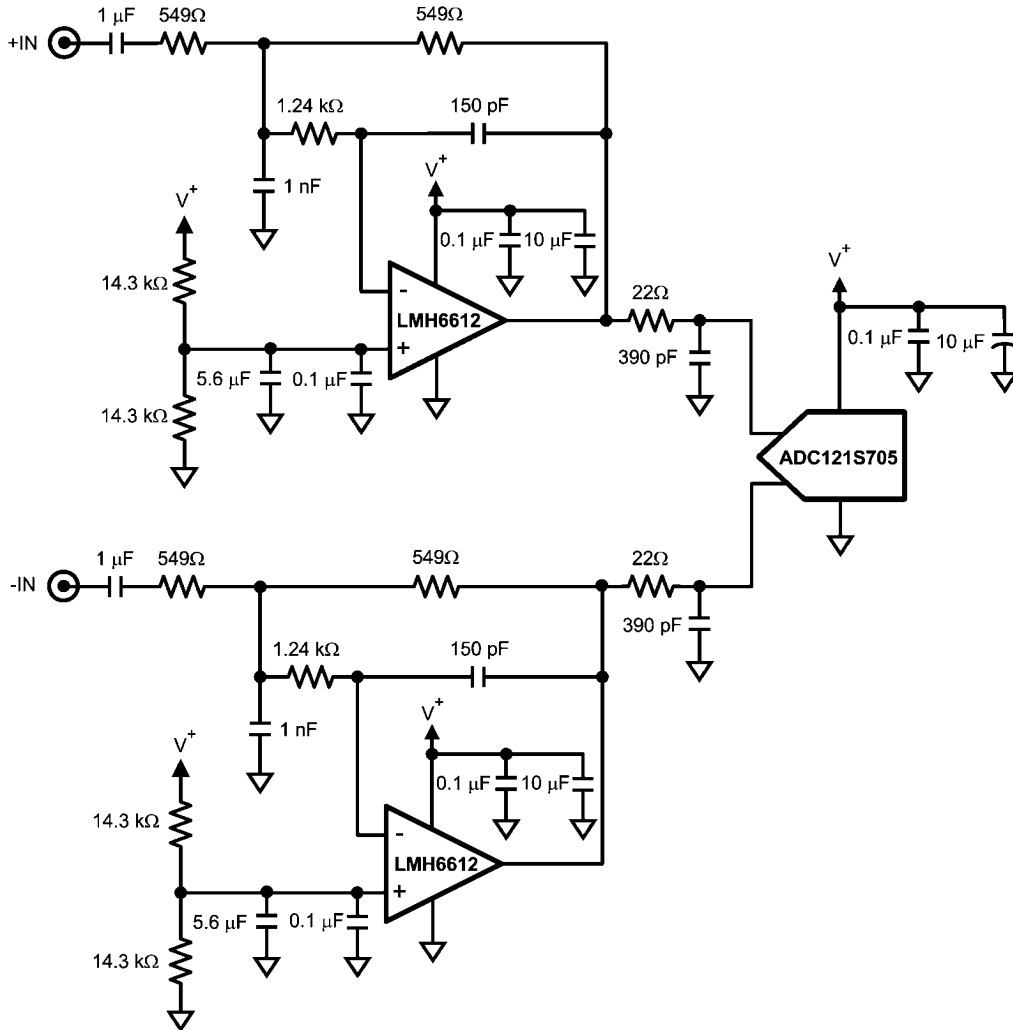

30033642

**FIGURE 7. Differential to Differential ADC Driver**



The following table summarizes the performance of the LMH6612 combined with the ADC121S625 at two different frequencies. In order to utilize the full dynamic range of the

ADC, the maximum input of 2.5 V<sub>PP</sub> is applied to the ADC input. *Figure 8* shows the FFT plot of the LMH6612 and ADC121S625 combination tested at f = 20 kHz input frequency.

**TABLE 3. Performance of the LMH6612 Combined with the ADC121S625**

| Amplifier Output/ADC Input | SINAD | SNR  | THD   | SFDR  | ENOB | Notes                    |
|----------------------------|-------|------|-------|-------|------|--------------------------|
|                            | (dB)  | (dB) | (dB)  | (dBc) |      |                          |
| 2.5                        | 72.2  | 72.3 | -87.7 | 92.1  | 11.7 | ADC121S625 @ f = 20 kHz  |
| 2.5                        | 72.2  | 72.2 | -87.8 | 90.8  | 11.7 | ADC121S625 @ f = 200 kHz |

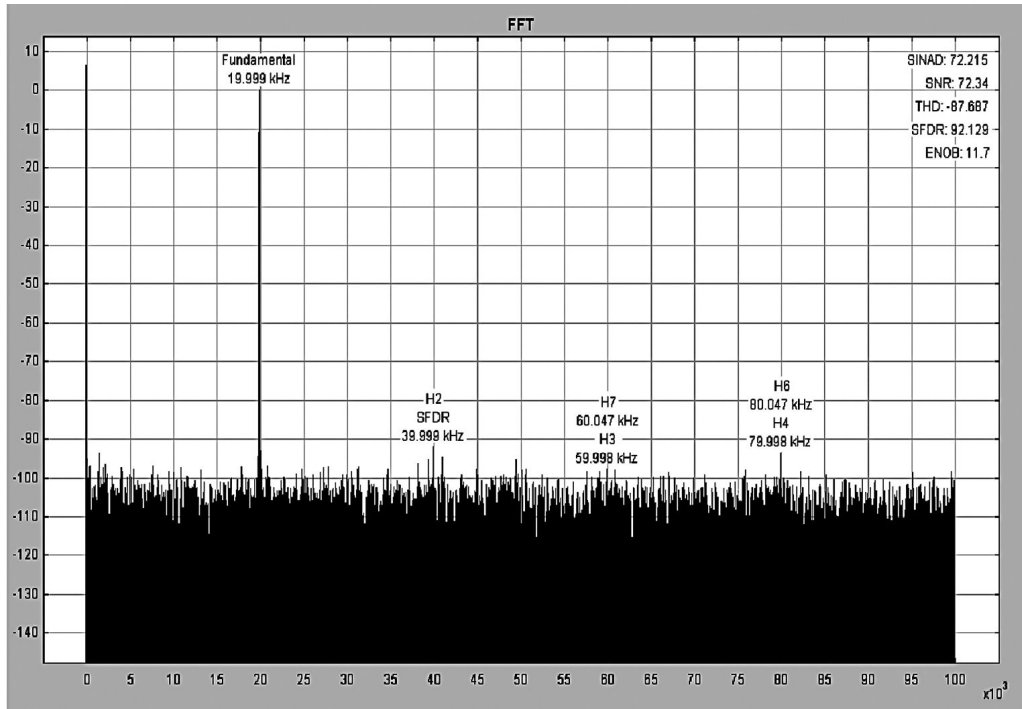

30033673

**FIGURE 8. The FFT Plot of Differential to Differential ADC Driver**

**DC LEVEL SHIFTING**

Often a signal must be both amplified and level shifted while using a single supply for the op amp. The circuit in *Figure 9* can do both of these tasks. The procedure for specifying the resistor values is as follows.

1. Determine the input voltage.
2. Calculate the input voltage midpoint,  $V_{INMID} = V_{INMIN} + (V_{INMAX} - V_{INMIN})/2$ .
3. Determine the output voltage needed.
4. Calculate the output voltage midpoint,  $V_{OUTMID} = V_{OUTMIN} + (V_{OUTMAX} - V_{OUTMIN})/2$ .
5. Calculate the gain needed,  $gain = (V_{OUTMAX} - V_{OUTMIN}) / (V_{INMAX} - V_{INMIN})$ .
6. Calculate the amount the voltage needs to be shifted from input to output,  $\Delta V_{OUT} = V_{OUTMID} - gain \times V_{INMID}$ .
7. Set the supply voltage to be used.
8. Calculate the noise gain,  $noise\ gain = gain + \Delta V_{OUT}/V_S$ .
9. Set  $R_F$ .
10. Calculate  $R_1$ ,  $R_1 = R_F/gain$ .
11. Calculate  $R_2$ ,  $R_2 = R_F/(noise\ gain - gain)$ .
12. Calculate  $R_G$ ,  $R_G = R_F/(noise\ gain - 1)$ .

Check that both the  $V_{IN}$  and  $V_{OUT}$  are within the voltage ranges of the LMH6611.

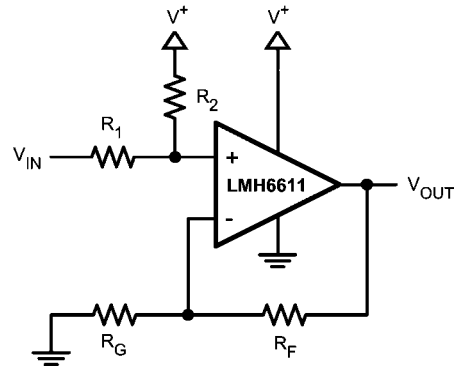

30033648

**FIGURE 9. DC Level Shifting**

The following example is for a  $V_{IN}$  of 0V to 1V with a  $V_{OUT}$  of 2V to 4V.

1.  $V_{IN} = 0V$  to  $1V$
2.  $V_{INMID} = 0V + (1V - 0V)/2 = 0.5V$
3.  $V_{OUT} = 2V$  to  $4V$
4.  $V_{OUTMID} = 2V + (4V - 2V)/2 = 3V$
5.  $Gain = (4V - 2V)/(1V - 0V) = 2$
6.  $\Delta V_{OUT} = 3V - 2 \times 0.5V = 2$
7. For the example the supply voltage will be +5V.
8.  $Noise\ gain = 2 + 2/5V = 2.4$
9.  $R_F = 2\ k\Omega$
10.  $R_1 = 2\ k\Omega/2 = 1\ k\Omega$
11.  $R_2 = 2\ k\Omega/(2.4 - 2) = 5\ k\Omega$
12.  $R_G = 2\ k\Omega/(2.4 - 1) = 1.43\ k\Omega$

**4th ORDER MULTIPLE FEEDBACK LOW-PASS FILTER**

*Figure 10* shows the LMH6612 used as the amplifier in a multiple feedback low pass filter. This filter is set up to have a gain

of +1 and a -3 dB point of 1 MHz. Values can be determined by using the WEBENCH® Active Filter Designer found at [www.amplifiers.national.com](http://www.amplifiers.national.com).

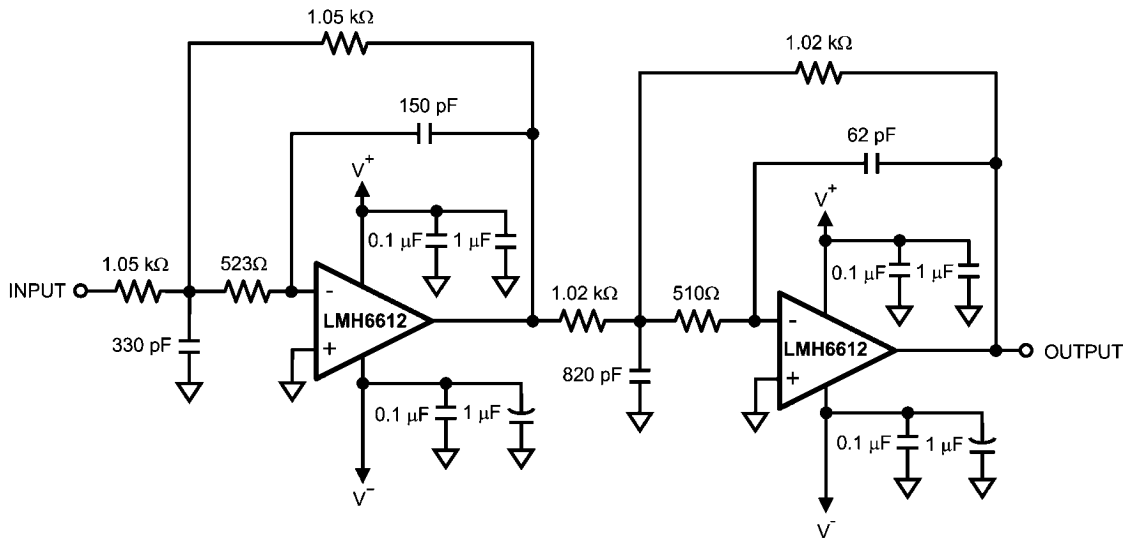

30033628

**FIGURE 10. 4th Order Multiple Feedback Low-Pass Filter**

**CURRENT SENSE AMPLIFIER AND OPTIMIZING ACCURACY IN PRECISION APPLICATIONS**

With its rail-to-rail output capability, low  $V_{OS}$ , and low  $I_B$  the LMH6611 is an ideal choice for a current sense amplifier application. Figure 11 shows the schematic of the LMH6611 set up in a low-side sense configuration which provides a conversion gain of 2V/A. Voltage error due to  $V_{OS}$  can be calculated to be  $V_{OS} \times (1 + R_F/R_G)$  or  $0.6 \text{ mV} \times 21 = 12.6 \text{ mV}$ . Voltage error due to  $I_O$  is  $I_O \times R_F$  or  $0.5 \mu\text{A} \times 1 \text{ k}\Omega = 0.5 \text{ mV}$ . Hence worst case total voltage error is  $12.6 \text{ mV} + 0.5 \text{ mV}$  or  $13.1 \text{ mV}$  which translates into a current error of  $13.1 \text{ mV}/(2 \text{ V/A}) = 6.55 \text{ mA}$ .

This circuit employs DC source resistance matching at the two input terminals in order to minimize the output DC error caused by input bias current. Another technique to reduce output offset in a non-inverting amplifier configuration is to introduce a DC offset current into the inverting input of the amplifier. To ensure minimal impact on frequency response be sure to inject the DC offset current through large resistors. Conversely if optimizing an inverting amplifier configuration simply apply offset adjustment to the non-inverting input.

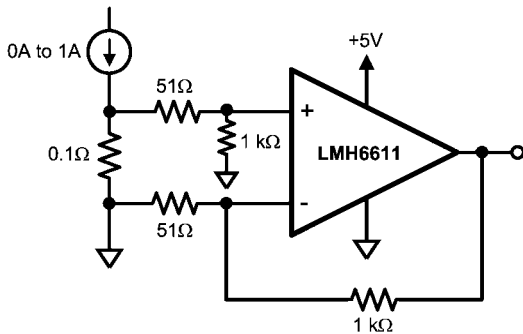

30033641

**FIGURE 11. Current Sense Amplifier**

**TRANSIMPEDANCE AMPLIFIER**

By definition, a photodiode produces either a current or voltage output from exposure to a light source. A Transimpedance Amplifier (TIA) is utilized to convert this low-level current to a usable voltage signal. The TIA often will need to be compensated to insure proper operation.

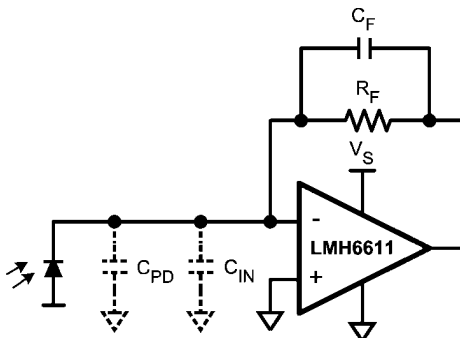

30033662

**FIGURE 12. Photodiode Modeled with Capacitance Elements**

Figure 12 shows the LMH6611 modeled with photodiode and the internal op amp capacitances. The LMH6611 allows circuit operation of a low intensity light due to its low input bias

current by using larger values of gain ( $R_F$ ). The total capacitance ( $C_T$ ) on the inverting terminal of the op amp includes the photodiode capacitance ( $C_{PD}$ ) and the input capacitance of the op amp ( $C_{IN}$ ). This total capacitance ( $C_T$ ) plays an important role in the stability of the circuit. The noise gain of this circuit determines the stability and is defined by:

$$NG = \frac{1 + sR_F(C_T + C_F)}{1 + sC_F R_F} \tag{1}$$

$$\text{Where, } f_z \cong \frac{1}{2\pi R_F C_T} \text{ and } f_p = \frac{1}{2\pi R_F C_F} \tag{2}$$

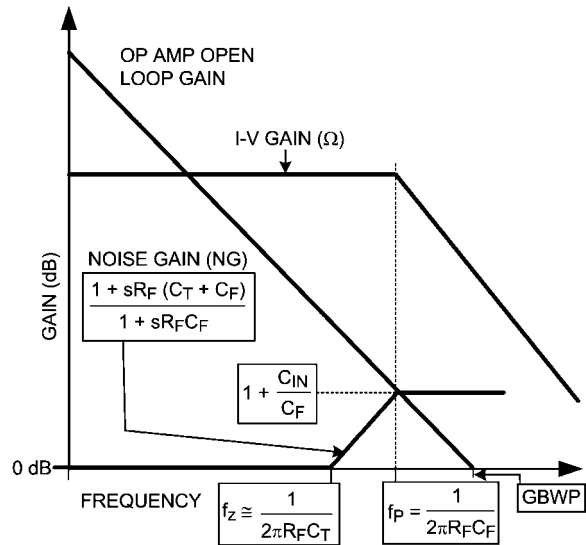

30033665

**FIGURE 13. Bode Plot of Noise Gain Intersecting with Op Amp Open Loop Gain**

Figure 13 shows the bode plot of the noise gain intersecting the op amp open loop gain. With larger values of gain,  $C_T$  and  $R_F$  create a zero in the transfer function. At higher frequencies the circuit can become unstable due to excess phase shift around the loop.

A pole at  $f_p$  in the noise gain function is created by placing a feedback capacitor ( $C_F$ ) across  $R_F$ . The noise gain slope is flattened by choosing an appropriate value of  $C_F$  for optimum performance.

Theoretical expressions for calculating the optimum value of  $C_F$  and the expected  $-3 \text{ dB}$  bandwidth are:

$$C_F = \sqrt{\frac{C_T}{2\pi R_F (GBWP)}} \tag{3}$$

$$f_{-3 \text{ dB}} = \sqrt{\frac{GBWP}{2\pi R_F C_T}} \tag{4}$$

Equation 4 indicates that the  $-3 \text{ dB}$  bandwidth of the TIA is inversely proportional to the feedback resistor. Therefore, if the bandwidth is important then the best approach would be to have a moderate transimpedance gain stage followed by a broadband voltage gain stage.

Table 4 shows the measurement results of the LMH6611 with different photodiodes having various capacitances ( $C_{PD}$ ) and a feedback resistance ( $R_F$ ) of  $1 \text{ k}\Omega$ .

TABLE 4. TIA (Figure 1) Compensation and Performance Results

| $C_{PD}$<br>(pF) | $C_T$<br>(pF) | $C_F$ CAL<br>(pF) | $C_F$ USED<br>(pF) | $f_{-3\text{ dB CAL}}$<br>(MHz) | $f_{-3\text{ dB MEAS}}$<br>(MHz) | Peaking<br>(dB) |
|------------------|---------------|-------------------|--------------------|---------------------------------|----------------------------------|-----------------|
| 22               | 24            | 5.42              | 5.6                | 29.3                            | 27.1                             | 0.5             |
| 47               | 49            | 7.75              | 8                  | 20.5                            | 21                               | 0.5             |
| 100              | 102           | 11.15             | 12                 | 14.2                            | 15.2                             | 0.5             |
| 222              | 224           | 20.39             | 18                 | 9.6                             | 10.7                             | 0.5             |
| 330              | 332           | 20.2              | 22                 | 7.9                             | 9                                | 0.8             |

Note:  
 GBWP = 130 MHz  
 $C_T = C_{PD} + C_{IN}$   
 $C_{IN} = 2\text{ pF}$   
 $V_S = \pm 2.5\text{ V}$

Figure 14 shows the frequency response for the various photodiodes in Table 4.

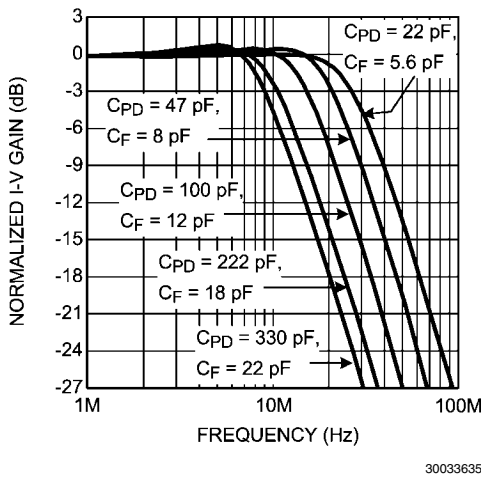

FIGURE 14. Frequency Response for Various Photodiode and Feedback Capacitors

When analyzing the noise at the output of the TIA, it is important to note that the various noise sources (i.e. op amp

noise voltage, feedback resistor thermal noise, input noise current, photodiode noise current) do not all operate over the same frequency band. Therefore, when the noise at the output is calculated, this should be taken into account. The op amp noise voltage will be gained up in the region between the noise gain's zero and pole ( $f_z$  and  $f_p$  in Figure 13). The higher the values of  $R_F$  and  $C_T$ , the sooner the noise gain peaking starts and therefore its contribution to the total output noise will be larger. It is advantageous to minimize  $C_{IN}$  by proper choice of op amp or by applying a reverse bias across the diode but this will be at the expense of excess dark current and noise.

**EVALUATION BOARD**

National Semiconductor provides the following evaluation board as a guide for high frequency layout and as an aid in device testing and characterization. Many of the datasheet plots were measured with this board:

| Device    | Package | Board Part # |
|-----------|---------|--------------|
| LMH6611MK | TSOT23  | LMH730216    |

This evaluation board can be shipped when a device sample request is placed with National Semiconductor.

**Physical Dimensions** inches (millimeters) unless otherwise noted

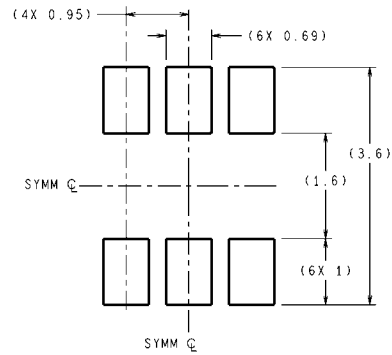
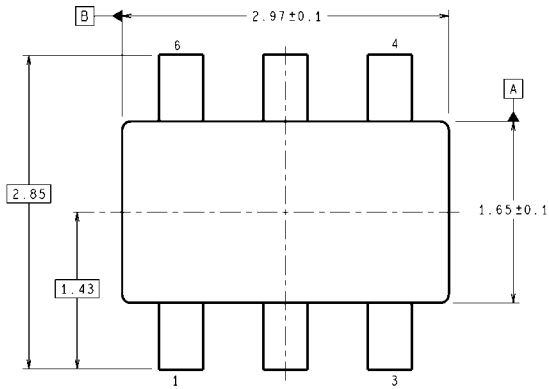

RECOMMENDED LAND PATTERN

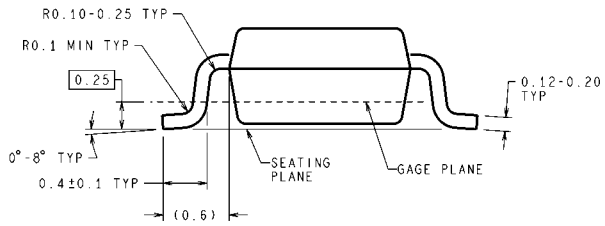
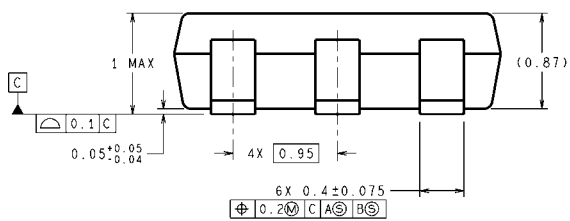

DIMENSIONS ARE IN MILLIMETERS

MK06A (Rev D)

**6-Pin TSOT23  
NS Package Number MK06A**

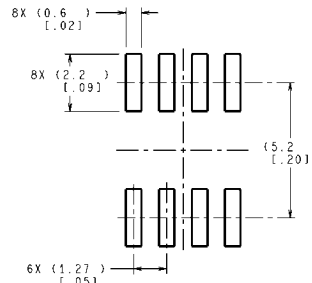
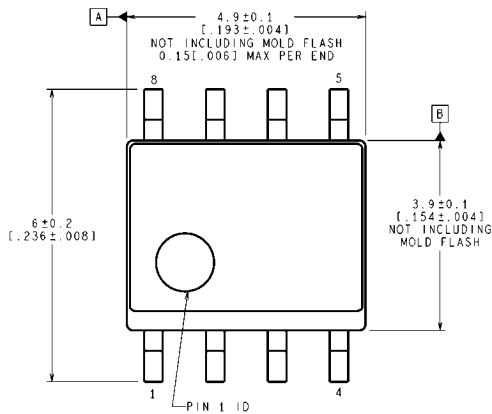

RECOMMENDED LAND PATTERN

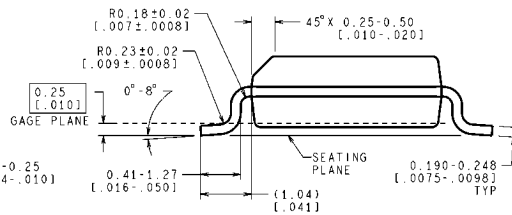
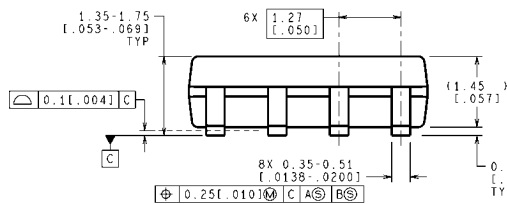

CONTROLLING DIMENSION IS MILLIMETER  
VALUES IN [ ] ARE INCHES  
DIMENSIONS IN ( ) FOR REFERENCE ONLY

M08A (Rev L)

**8-Pin SOIC  
NS Package Number M08A**

For more National Semiconductor product information and proven design tools, visit the following Web sites at:

| Products                       |  | Design Support          |  |
|--------------------------------|--|-------------------------|--|
| Amplifiers                     | <a href="http://www.national.com/amplifiers">www.national.com/amplifiers</a>   | WEBENCH                 | <a href="http://www.national.com/webench">www.national.com/webench</a>             |
| Audio                          | <a href="http://www.national.com/audio">www.national.com/audio</a>             | Analog University       | <a href="http://www.national.com/AU">www.national.com/AU</a>                       |
| Clock Conditioners             | <a href="http://www.national.com/timing">www.national.com/timing</a>           | App Notes               | <a href="http://www.national.com/appnotes">www.national.com/appnotes</a>           |
| Data Converters                | <a href="http://www.national.com/adc">www.national.com/adc</a>                 | Distributors            | <a href="http://www.national.com/contacts">www.national.com/contacts</a>           |
| Displays                       | <a href="http://www.national.com/displays">www.national.com/displays</a>       | Green Compliance        | <a href="http://www.national.com/quality/green">www.national.com/quality/green</a> |
| Ethernet                       | <a href="http://www.national.com/ethernet">www.national.com/ethernet</a>       | Packaging               | <a href="http://www.national.com/packaging">www.national.com/packaging</a>         |
| Interface                      | <a href="http://www.national.com/interface">www.national.com/interface</a>     | Quality and Reliability | <a href="http://www.national.com/quality">www.national.com/quality</a>             |
| LVDS                           | <a href="http://www.national.com/lvds">www.national.com/lvds</a>               | Reference Designs       | <a href="http://www.national.com/refdesigns">www.national.com/refdesigns</a>       |
| Power Management               | <a href="http://www.national.com/power">www.national.com/power</a>             | Feedback                | <a href="http://www.national.com/feedback">www.national.com/feedback</a>           |
| Switching Regulators           | <a href="http://www.national.com/switchers">www.national.com/switchers</a>     |                         |  |
| LDOs                           | <a href="http://www.national.com/lido">www.national.com/lido</a>               |                         |  |
| LED Lighting                   | <a href="http://www.national.com/led">www.national.com/led</a>                 |                         |  |
| PowerWise                      | <a href="http://www.national.com/powerwise">www.national.com/powerwise</a>     |                         |  |
| Serial Digital Interface (SDI) | <a href="http://www.national.com/sdi">www.national.com/sdi</a>                 |                         |  |
| Temperature Sensors            | <a href="http://www.national.com/tempsensors">www.national.com/tempsensors</a> |                         |  |
| Wireless (PLL/VCO)             | <a href="http://www.national.com/wireless">www.national.com/wireless</a>       |                         |  |

THE CONTENTS OF THIS DOCUMENT ARE PROVIDED IN CONNECTION WITH NATIONAL SEMICONDUCTOR CORPORATION ("NATIONAL") PRODUCTS. NATIONAL MAKES NO REPRESENTATIONS OR WARRANTIES WITH RESPECT TO THE ACCURACY OR COMPLETENESS OF THE CONTENTS OF THIS PUBLICATION AND RESERVES THE RIGHT TO MAKE CHANGES TO SPECIFICATIONS AND PRODUCT DESCRIPTIONS AT ANY TIME WITHOUT NOTICE. NO LICENSE, WHETHER EXPRESS, IMPLIED, ARISING BY ESTOPPEL OR OTHERWISE, TO ANY INTELLECTUAL PROPERTY RIGHTS IS GRANTED BY THIS DOCUMENT.

TESTING AND OTHER QUALITY CONTROLS ARE USED TO THE EXTENT NATIONAL DEEMS NECESSARY TO SUPPORT NATIONAL'S PRODUCT WARRANTY. EXCEPT WHERE MANDATED BY GOVERNMENT REQUIREMENTS, TESTING OF ALL PARAMETERS OF EACH PRODUCT IS NOT NECESSARILY PERFORMED. NATIONAL ASSUMES NO LIABILITY FOR APPLICATIONS ASSISTANCE OR BUYER PRODUCT DESIGN. BUYERS ARE RESPONSIBLE FOR THEIR PRODUCTS AND APPLICATIONS USING NATIONAL COMPONENTS. PRIOR TO USING OR DISTRIBUTING ANY PRODUCTS THAT INCLUDE NATIONAL COMPONENTS, BUYERS SHOULD PROVIDE ADEQUATE DESIGN, TESTING AND OPERATING SAFEGUARDS.

EXCEPT AS PROVIDED IN NATIONAL'S TERMS AND CONDITIONS OF SALE FOR SUCH PRODUCTS, NATIONAL ASSUMES NO LIABILITY WHATSOEVER, AND NATIONAL DISCLAIMS ANY EXPRESS OR IMPLIED WARRANTY RELATING TO THE SALE AND/OR USE OF NATIONAL PRODUCTS INCLUDING LIABILITY OR WARRANTIES RELATING TO FITNESS FOR A PARTICULAR PURPOSE, MERCHANTABILITY, OR INFRINGEMENT OF ANY PATENT, COPYRIGHT OR OTHER INTELLECTUAL PROPERTY RIGHT.

**LIFE SUPPORT POLICY**

**NATIONAL'S PRODUCTS ARE NOT AUTHORIZED FOR USE AS CRITICAL COMPONENTS IN LIFE SUPPORT DEVICES OR SYSTEMS WITHOUT THE EXPRESS PRIOR WRITTEN APPROVAL OF THE CHIEF EXECUTIVE OFFICER AND GENERAL COUNSEL OF NATIONAL SEMICONDUCTOR CORPORATION.** As used herein:

Life support devices or systems are devices which (a) are intended for surgical implant into the body, or (b) support or sustain life and whose failure to perform when properly used in accordance with instructions for use provided in the labeling can be reasonably expected to result in a significant injury to the user. A critical component is any component in a life support device or system whose failure to perform can be reasonably expected to cause the failure of the life support device or system or to affect its safety or effectiveness.

National Semiconductor and the National Semiconductor logo are registered trademarks of National Semiconductor Corporation. All other brand or product names may be trademarks or registered trademarks of their respective holders.

Copyright© 2008 National Semiconductor Corporation  
 For the most current product information visit us at [www.national.com](http://www.national.com)

|  |  |   |  |
|--|--|---|--|
|  <p><b>National Semiconductor Americas Technical Support Center</b><br/>                 Email: <a href="mailto:support@nsc.com">support@nsc.com</a><br/>                 Tel: 1-800-272-9959</p> | <p><b>National Semiconductor Europe Technical Support Center</b><br/>                 Email: <a href="mailto:europe.support@nsc.com">europe.support@nsc.com</a><br/>                 German Tel: +49 (0) 180 5010 771<br/>                 English Tel: +44 (0) 870 850 4288</p> | <p><b>National Semiconductor Asia Pacific Technical Support Center</b><br/>                 Email: <a href="mailto:ap.support@nsc.com">ap.support@nsc.com</a></p> | <p><b>National Semiconductor Japan Technical Support Center</b><br/>                 Email: <a href="mailto:jpn.feedback@nsc.com">jpn.feedback@nsc.com</a></p> |
|--|--|---|--|